

# Attaches, fils & toiles métalliques / Wire goods & fasteners

## GOUPILLE À ANNEAU

Zinguée jaune.

Numéro produit Product number	Numéro produit avec codes à barres  Product number with bar code	F		S		Boîte Box	Emb. Pack
		Diamètre tige Shank diameter		Longueur tige Shank length			
		po. / in.	mm	po. / in.	mm		
S35	S35BC	3/16"	5.0	1-9/16"	40	100	10
S37	S37BC	1/4"	6.0	1-3/4"	45	100	10
S38	S38BC	5/16"	8.0	1-3/4"	45	100	10
S36	S36BC	3/8"	9.5	1-3/4"	45	100	10
S6	S6BC	7/16"	11.0	1-3/4"	45	100	10

## LINCH PIN

Yellow chromate plating.



### ANNEAU RESSORT ULTRA ROBUSTE

### HEAVY DUTY PIN

P7913	P7913BC	7/16"	11.0	2"	50	100	10
-------	---------	-------	------	----	----	-----	----

Anneau diam. ring 0.192"/4.9 mm

## GOUPILLE À RESSORT

Electro galvanisée.

Numéro produit Product number	Boîte Box	Diamètre tige Shank diameter		Longueur totale Total length		Numéro produit en sac poly avec code à barres  Product number poly bag with bar code	Quantité par sac Quantity per bag	Sacs par boîte Bags per box
		po. / in.	mm	po. / in.	mm			
S8	50	5/64"	2.0	1-5/8"	41	S8-P	5	10
S9	50	3/32"	2.5	1-3/4"	45	S9-P	5	10
S10	50	1/8"	3.0	2-5/8"	67	S10-P	5	10
S12	50	5/32"	4.0	3"	75	S12-P	2	10
S13	25	7/32"	5.0	4-1/8"	105	S13-P	2	10
S14	25	1/4"	6.0	4-5/8"	117	S14-P	1	10
S15	25	5/16"	7.0	6-1/2"	165	S15-P	1	10

## SPRING PIN GRIP CLIP

Bright zinc plating.



## ASSORTIMENT DE GOUPILLES À RESSORT

### S19

L'assortiment comprend  
Assortment consists of  
356 pins

100 x S8	20 x S13
60 x S9	10 x S14
60 x S10	6 x S15
100 x S12	



## SPRING PIN ASSORTMENT

S19

## GOUPILLE D'ATTACHE

Alliage d'acier forgé traité à chaud, galvanisé.  
Grosse poignée robuste, goupille à ressort incluse.  
Avec étiquette code à barres.

Numéro produit Product number	F	S	Emb. Pack
	Diamètre tige Shank diameter	Longueur tige Shank length	
	po. / in.		
5006	1/2"	3-5/8"	1
5008	5/8"	4"	1
5010	5/8"	5-1/2"	1
5012	3/4"	4-1/2"	1
5014	3/4"	6-1/2"	1
5016	7/8"	4-1/2"	1
5018	7/8"	6-1/2"	1
5020	1"	4-1/2"	1
5022	1"	7-1/2"	1

## HITCH PIN

Drop forged from alloy steel, heat treated, hot galvanized. Heavy duty large handle, included assembled spring pin. With bar code sticker.

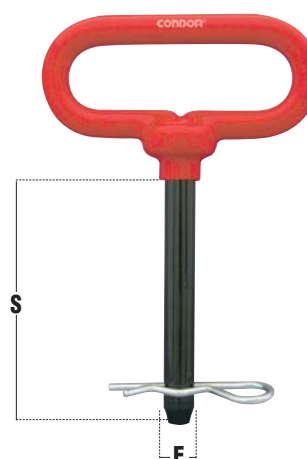

# Attaches, fils & toiles métalliques / Wire goods & fasteners

## GOUPILLES RAPIDES

Acier plaqué zinc clair.

NOUVEAU / NEW

## QUICK PINS

Clear zinc plated steel.

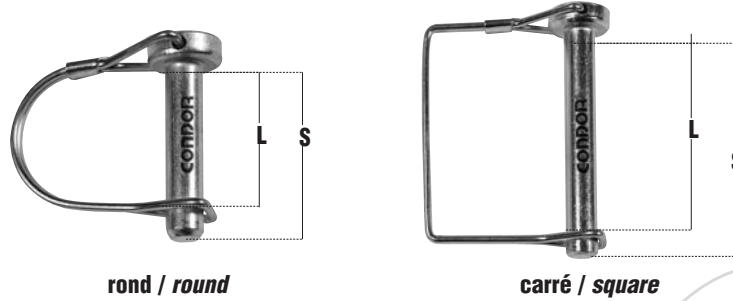

rond / round

carré / square

Numéro produit Product number	Numéro produit avec code à barres  Product number with bar code	Description	Diamètre tige Pin diameter	L	S	Emb. Pack
S60	S60BC	Rond / Round	1/4"	1-3/8"	1-5/8"	5
S61	S61BC	Rond / Round	1/4"	1-3/4"	2"	5
S62	S62BC	Carré / Square	1/4"	2-1/2"	2-3/4"	5
S63	S63BC	Rond / Round	5/16"	1-3/8"	1-5/8"	5
S64	S64BC	Rond / Round	5/16"	1-3/4"	2"	5
S65	S65BC	Carré / Square	5/16"	2-1/2"	2-3/4"	5
S66	S66BC	Rond / Round	3/8"	1-3/8"	1-5/8"	5
S67	S67BC	Carré / Square	3/8"	2-1/4"	2-1/2"	5
S68	S68BC	Carré / Square	3/8"	2-1/2"	2-3/4"	5

## CROCHETS À RIDELLE

En fonte malléable plaquée zinc. Avec étiquette code à barres.

## STAKE RACK FASTENERS

Zinc plated malleable iron. With bar code sticker.

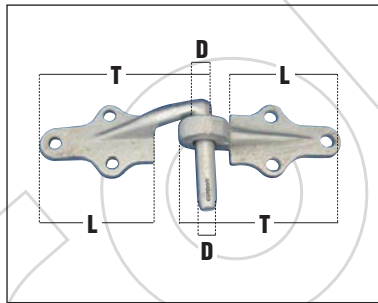

Numéro produit Product number	Type Type	D	L	T	Emb. Pack
		Diamètre Diameter	Longueur corps Body length	Longueur totale Overall length	
po. / in.					
57E1	Oeil - Eye	11/16"	3-1/2"	5-1/8"	1
57L3	Crochet gauche - Left hook	9/16"	3-1/2"	5-1/2"	1
57R3	Crochet droit - Right hook	9/16"	3-1/2"	5-1/2"	1



# Attaches, fils & toiles métalliques / Wire goods & fasteners

## TIGE FILETÉE

Tige en acier doux plaqué zinc, longueur entièrement filetée, gros filet U.N.C.

## THREADED ROD

Mild zinc plated steel rod, threaded full length, U.N.C. coarse thread.

### LONGUEUR 36 po/in. LENGTH

Numéro produit Product number	Diamètre Diameter	Bout coloré End colour coded	Poids / 100 Weight/ 100	Emb. Pack
	po. / in.		lb	
TR36P - 06	1/4"	Bleu ● Blue	36	25
TR36P - 08	5/16"	Rouge ● Red	59	20
TR36P - 10	3/8"	Jaune ○ Yellow	88	15
TR36P - 11	7/16"	Vert ● Green	120	10
TR36P - 13	1/2"	Bleu ● Blue	159	10
TR36P - 16	5/8"	Rouge ● Red	253	5
TR36P - 19	3/4"	Jaune ○ Yellow	370	5
TR36P - 22	7/8"	Orange ○ Orange	511	3
TR36P - 25	1"	Noir ● Black	668	3

### LONGUEUR 72 po/in. LENGTH

TR72P - 06	1/4"	Bleu ● Blue	72	10
TR72P - 08	5/16"	Rouge ● Red	115	10
TR72P - 10	3/8"	Jaune ○ Yellow	173	10
TR72P - 11	7/16"	Vert ● Green	240	10
TR72P - 13	1/2"	Bleu ● Blue	318	10
TR72P - 16	5/8"	Rouge ● Red	504	5
TR72P - 19	3/4"	Jaune ○ Yellow	732	5
TR72P - 22	7/8"	Orange ○ Orange	1,022	3
TR72P - 25	1"	Noir ● Black	1,336	3



Bout peinturé d'une couleur pour identifier le diamètre de la tige.

Each end colour coded to identify the diameter of the rod.

TR

NOUVELLES GRANDEURS  
NEW SIZES

## TIGE NON-FILETÉE

Tige en acier doux plaqué zinc, longueur entièrement lisse.

NOUVEAU / NEW

## UNTHREADED ROD

Mild zinc plated steel rod, smooth full length.

### LONGUEUR 36 po/in. LENGTH

Numéro produit Product number	Diamètre Diameter	Bout coloré End colour coded	Poids / 100 Weight/ 100	Emb. Pack
	po. / in.		lb	
TN36P - 06	1/4"	Bleu ● Blue	50	25
TN36P - 08	5/16"	Rouge ● Red	78	20
TN36P - 10	3/8"	Jaune ○ Yellow	112	15
TN36P - 13	1/2"	Bleu ● Blue	200	10
TN36P - 16	5/8"	Rouge ● Red	310	5



TN

## PRÉSENTOIR CONDOR POUR TIGES ET CHARNIÈRES À PIANO

Robuste présentoir en acier noir métallisé. Voir notre représentant au sujet du contenu et du prix de ce présentoir.

## ROD & PIANO HINGE CONDOR DISPLAY

Heavy silver vein steel display rack. Ask our sales representative for contents and price of this display.

### Dimensions (support)

24 pouces de largeur  
x 16 pouces de profondeur  
x 47 pouces de hauteur.



PR220

NOUVEAU / NEW

### Dimensions (stand)

24 inches of width  
x 16 inches of depth  
x 47 inches of height.



# Attaches, fils & toiles métalliques / Wire goods & fasteners

## PITON AVEC ÉCROU

Fini plaqué zinc poli.

## EYE BOLT WITH NUT

Bright zinc plated finish.

Numéro produit avec code à barres sur l'emballage Product number with bar code on the pack	Numéro produit avec code à barres  Product number with bar code	F	T	D	L	S	Emb. Pack
		Diamètre filetage Thread diameter	Longueur totale Overall length	Diamètre intérieur oeillet Eye inside diameter	Longueur filetage Thread length	Longueur tige Shank length	
po. / in.							
AN5102	AN5102BC	3/16"	2"	3/8"	1-1/8"	1-5/16"	10
AN5104	AN5104BC	3/16"	2-1/2"	3/8"	1-5/8"	1-3/4"	10
AN5106	AN5106BC	1/4"	2"	9/16"	7/8"	1"	10
AN5107	AN5107BC	1/4"	2-1/2"	9/16"	1-3/8"	1-1/2"	10
AN5108	AN5108BC	1/4"	3"	9/16"	1-3/4"	2"	10
AN5109	AN5109BC	1/4"	4"	9/16"	2-3/4"	3"	10
AN5110	AN5110BC	1/4"	5"	9/16"	3"	4"	10
AN5111	AN5111BC	1/4"	6"	9/16"	3"	5"	10
AN5112	AN5112BC	5/16"	3-1/4"	11/16"	1-3/4"	2"	10
AN5113	AN5113BC	5/16"	4"	11/16"	2-1/2"	2-3/4"	10
AN5114	AN5114BC	5/16"	5"	11/16"	3"	3-3/4"	10
AN5115	AN5115BC	5/16"	6"	11/16"	3"	4-3/4"	10
AN5117	AN5117BC	3/8"	4"	7/8"	2-1/8"	2-3/8"	10
AN5118	AN5118BC	3/8"	5"	7/8"	2-3/4"	3-3/8"	10
AN5119	AN5119BC	3/8"	6"	7/8"	2-3/4"	4-3/8"	10
AN5120	AN5120BC	3/8"	8"	7/8"	2-3/4"	6-3/8"	10
AN5226	AN5226BC	1/2"	6"	1-1/4"	3"	4"	5
AN5228	AN5228BC	1/2"	8"	1-1/4"	3"	6"	5
AN5229	AN5229BC	1/2"	10"	1-1/4"	3"	8"	5
AN5230	AN5230BC	1/2"	12"	1-1/4"	3"	10"	5

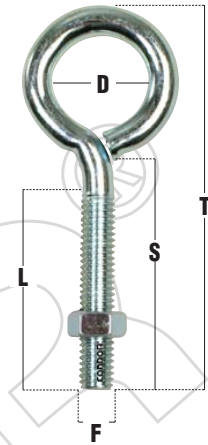

## BOULON EN "U"

Avec plaque & écrous, fini plaqué zinc poli.

## "U" BOLT

With plate & hex nuts, bright zinc plated finish.

Numéro produit avec code à barres sur l'emballage Product number with bar code on the pack	Numéro produit avec code à barres  Product number with bar code	F	Diamètre tuyau To fit steel pipe	A	P	L	Emb. Pack
		Diamètre filetage Thread diameter		Largeur interne Inside width	Profondeur int. Inside length	Longueur filetage Thread length	
po. / in.							
AN5121	AN5121BC	1/4"	3/4"	1-1/8"	2"	7/8"	10
AN5122	AN5122BC	5/16"	1"	1-3/8"	2-3/16"	1"	10
AN5123	AN5123BC	5/16"	1-1/4"	1-3/4"	2-11/16"	1"	10
AN5124	AN5124BC	5/16"	1-1/2"	2"	2-3/4"	1"	10
AN5125	AN5125BC	5/16"	2"	2-1/2"	3-1/4"	1-1/4"	10
AN5161	AN5161BC	5/16"	1"	1-3/8"	3-11/16"	2-3/8"	10
AN5162	AN5162BC	5/16"	1-1/4"	1-3/4"	4-3/16"	2-3/4"	10
AN5164	AN5164BC	5/16"	1-1/2"	2"	4-11/16"	3"	10
AN5166	AN5166BC	5/16"	2"	2-1/2"	5-3/16"	3-1/8"	10

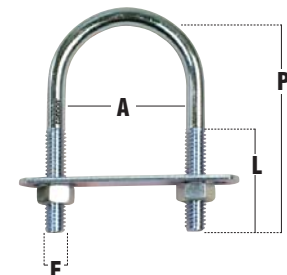



# Attaches, fils & toiles métalliques / Wire goods & fasteners

## TENDEURS

Zinc coulé sous pression, fini plaqué zinc poli.

## TURNBUCKLES

Zinc pressure die cast bodies, bright zinc plated finish.

Numéro produit avec code à barres sur l'emballage Product number with bar code on the pack	Numéro produit avec code à barres Product number with bar code	Diamètre filetage Thread Diameter	Longueur fermée Closed length	Longueur ouverte Opened length	D		Emb. Pack
					Diamètre int. oeillet Eye inside diameter	Longueur corps Body length	
AN5011	AN5011BC	5/32"	3-1/2"	4-3/4"	7/32"	1-3/4"	10
AN5012	AN5012BC	3/16"	3-7/8"	5-1/2"	1/4"	2-1/4"	10
AN5013	AN5013BC	7/32"	4-1/2"	6-3/8"	5/16"	2-3/4"	10
AN5014	AN5014BC	1/4"	5-1/2"	7-5/8"	11/32"	3-1/8"	10
AN5015	AN5015BC	5/16"	6-3/4"	9-3/8"	3/8"	3-3/4"	10
AN5016	AN5016BC	3/8"	7-1/2"	10-1/2"	1/2"	4-1/8"	10
AN5021	AN5021BC	5/32"	3-1/2"	4-3/4"	7/32"	1-3/4"	10
AN5022	AN5022BC	3/16"	3-7/8"	5-1/2"	1/4"	2-1/4"	10
AN5023	AN5023BC	7/32"	4-1/2"	6-3/8"	5/16"	2-3/4"	10
AN5024	AN5024BC	1/4"	5-1/2"	7-5/8"	11/32"	3-1/8"	10
AN5025	AN5025BC	5/16"	6-3/4"	9-3/8"	3/8"	3-3/4"	10
AN5026	AN5026BC	3/8"	7-1/2"	10-1/2"	1/2"	4-1/8"	10

AN5011  
Oeil & oeil  
Eye & eye

AN5021  
Oeil & crochet  
Hook & eye

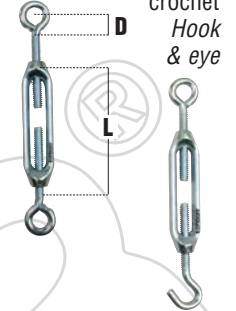

## CROCHET EN "S"

En acier fini plaqué zinc poli.

### "S" HOOK

Steel with bright zinc plated finish.

NOUVELLE GRANDEUR  
NEW SIZE

Numéro produit avec code à barres sur l'emballage Product number with bar code on the pack	Numéro produit avec code à barres Product number with bar code	Diam. fil Wire diam.	A	O	T	Emb. en vrac Pack in bulk	Emb. en "BC" Pack in "BC"
			Largeur Width	Ouverture oeil Open eye	Long. totale Overall length		
AN5130	AN5130BC	3/32"	5/8"	1/4"	1"	100	20
AN5131	AN5131BC	1/8"	15/16"	3/8"	1-1/2"	20	20
AN5132	AN5132BC	3/16"	1-3/16"	7/16"	2"	20	20
AN5134	AN5134BC	1/4"	1-7/16"	5/8"	2-1/2"	20	20
AN5136	AN5136BC	5/16"	1-3/4"	19/32"	3"	20	20
AN5137	AN5137BC	5/16"	1-15/16"	5/8"	3-1/2"	20	20

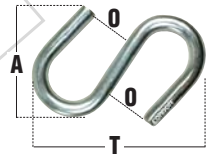

## CROCHETS DE CORDE À LINGE

Fini plaqué zinc.



Numéro produit avec code à barres sur l'emballage Product number with bar code on the pack	Numéro produit avec code à barres Product number with bar code	F	T	Emb. Pack
		Diamètre fil Wire Diameter	Longueur totale Overall length	
AN5187	AN5187BC	11/32"	7-1/2"	10
AN5188	AN5188BC	5/16"	8-1/2"	20

## CLOTHESLINE HOOKS

Zinc plated finish.



## OEILLETS À VIS

Fini plaqué zinc poli.

### SCREW EYES

Bright zinc plated finish.

Numéro produit avec code à barres sur l'emballage Product number with bar code on the pack	T	S	F	D	Emb. Pack
	Longueur totale Overall length	Longueur tige Shank length	Diamètre fil Wire diameter	Diamètre interne oeillet Eye inside diameter	
AN5401	5/8"	3/8"	1/16"	1/8"	100
AN5402	3/4"	15/32"	3/32"	9/64"	100
AN5404	7/8"	9/16"	3/32"	5/32"	100
AN5406	1-3/32"	37/64"	1/8"	13/64"	100
AN5408	1-5/16"	3/4"	5/32"	1/4"	100
AN5410	1-9/16"	15/16"	3/16"	9/32"	100
AN5415	1/2"	7/32"	1/16"	9/64"	100
AN5417	7/16"	7/32"	1/16"	1/8"	100
AN5501	13/16"	1/2"	1/16"	7/32"	100
AN5502	7/8"	1/2"	3/32"	15/64"	100
AN5504	1"	9/16"	3/32"	9/32"	100
AN5506	1-1/8"	5/8"	1/8"	5/16"	100
AN5508	1-5/16"	3/4"	5/32"	11/32"	100
AN5510	1-9/16"	7/8"	3/16"	3/8"	100
AN5512	1-7/8"	1-1/8"	7/32"	15/32"	100
AN5516	2-3/8"	1-3/8"	9/32"	17/32"	50
AN5518	2-5/8"	1-1/2"	5/16"	9/16"	100
AN5520	2-7/8"	1-5/8"	5/16"	5/8"	100

Série "A"  
Petit oeillet  
"A" series  
Small eye

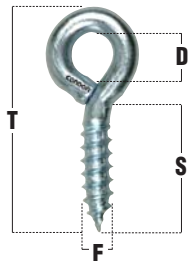

Série "B"  
Moyen oeillet  
"B" series  
Medium eye



# Attaches, fils & toiles métalliques / Wire goods & fasteners

## PITON À BOIS, TIRE-FOND

Fini plaqué zinc poli.

Numéro produit avec code à barres sur l'emballage Product number with bar code on the pack	Numéro produit avec code à barres Product number with bar code	F	L	T	S	D	Emb. Pack
		Diamètre filetage Thread diameter	Longueur filetage Thread length	Longueur totale Overall length	Longueur tige Shank length	Diamètre int. oeillet Eye inside diameter	
		po. / in.					
AN5151	AN5151BC	1/4"	1-9/16"	3-3/4"	2-3/4"	9/16"	10
AN5152	AN5152BC	1/4"	1-9/16"	5"	4"	9/16"	10
AN5153	AN5153BC	5/16"	1-9/16"	4"	2-3/4"	3/4"	10
AN5154	AN5154BC	5/16"	1-9/16"	6"	4-3/4"	3/4"	10
AN5155	AN5155BC	3/8"	1-3/4"	4-1/2"	3"	7/8"	10
AN5156	AN5156BC	3/8"	1-3/4"	8"	6-1/4"	7/8"	10

## EYE LAG BOLT

Lag thread bright zinc plated finish.

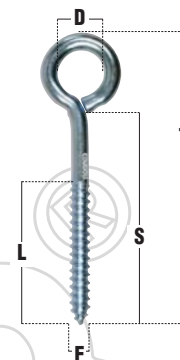

## CROCHET DE PORTE

Fini plaqué zinc poli.

NOUVEL EMBALLAGE / NEW PACK

Numéro produit avec code à barres sur l'emballage Product number with bar code on the pack	F	L	Emb. Pack	No. produit en sac poly avec code à barres Product no. poly bag with bar code	Qte / sac Qty / Bag	Sacs / Bte Bags / Box
	Diamètre fil Wire diameter	Longueur Length				
	po. / in.					
AN5815	1/8"	1-1/2"	100	AN5815-P	2	20
AN5820	5/32"	2"	100	AN5820-P	2	20
AN5825	5/32"	2-1/2"	100	AN5825-P	2	20
AN5830	3/16"	3"	100	AN5830-P	2	20
AN5840	3/16"	4"	50	AN5840-P	2	20
AN5860	1/4"	6"	50	----	---	---

## GATE HOOK

Lag thread bright zinc plated finish.



Avec étiquette code à barres With bar code sticker

AN5908BC	3/16"	8"	50
AN5910BC	3/16"	10"	20
AN5912BC	3/16"	12"	20

NOUVEL EMBALLAGE / NEW PACK

## CROCHET DE CORDE À LINGE

Fini plaqué zinc. Vis incluses. En sac poly.

NOUVEAU / NEW

Numéro produit avec code à barres Product number with bar code	Diamètre fil Wire diameter	Projection crochet / hook	Dim. plaque Plate size	Emb. Pack
	po/in.			
AN5179BC	5/16"	2"	2" x 2"	12



## CLOTHESLINE HOOK

Zinc plated finish.  
Screws included.  
In poly bag.

AN5179BC

## ANNEAUX D'ACCROCHAGE

Fini plaqué zinc.

Numéro produit avec code à barres sur l'emballage Product number with bar code on the pack	Numéro produit avec code à barres Product number with bar code	Description	Diamètre anneau Ring diameter	Emb. Pack
			po/in.	
AN5177	AN5177BC	À bois 2-1/2" / Lag thread	2" x 5/16"	10
AN5178	AN5178BC	Avec plaque 2" x 2" / with plate	2" x 5/16"	10



## HITCHING RINGS

Zinc plated finish.

AN5178

AN5177

## BOULON À ANNEAU

Fini plaqué zinc.

Numéro produit avec code à barres sur l'emballage Product number with bar code on the pack	Numéro produit avec code à barres Product number with bar code	Diamètre anneau Ring diameter	Longueur boulon Bolt length	Diamètre filetage Thread diameter	Emb. Pack
		po/in.			
AN5172	AN5172BC	2" x 9/32"	2-1/2"	3/8"	10
AN5173	AN5173BC	2" x 9/32"	6"	3/8"	10



## RING BOLT

Zinc plated finish.

AN5173

# Attaches, fils & toiles métalliques / Wire goods & fasteners

## CROCHET À VIS EN LAITON

## BRASS SCREW HOOK

NOUVEL EMBALLAGE / NEW PACK

Numéro produit avec code à barres sur l'emballage Product number with bar code on the pack	G	F	T	Emb. Pack	Numéro produit en sac poly avec code à barres P-pack Product number poly bag with bar code	Qté / sac Qty / Bag	Sacs / Bte Bags / Box
	Grandeur Size	Diamètre fil Wire diameter po. / in.	Longueur totale Overall length				
AN5750	1/2"	1/16"	7/8"	100	AN5750-P	4	20
AN5752	3/4"	3/32"	1-1/8"	100	AN5752-P	4	20
AN5754	1"	1/8"	1-1/2"	100	AN5754-P	4	20

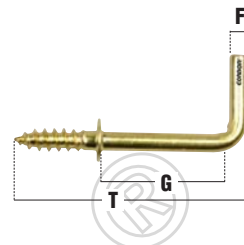

## CROCHET EN LAITON POUR TASSE

## BRASS CUP HOOK

NOUVEL EMBALLAGE / NEW PACK

Numéro produit avec code à barres sur l'emballage Product number with bar code on the pack	G	F	T	Emb. Pack	Numéro produit en sac poly avec code à barres P-pack Product number poly bag with bar code	Qté / sac Qty / Bag	Sacs / Bte Bags / Box
	Grandeur Size	Diamètre fil Wire diameter po. / in.	Longueur totale Overall length				
AN5780	1/2"	3/32"	7/8"	100	AN5780-P	6	25
AN5781	5/8"	3/32"	1"	100	AN5781-P	5	25
AN5782	3/4"	3/32"	1-1/8"	100	AN5782-P	5	25
AN5783	7/8"	1/8"	1-5/16"	100	AN5783-P	5	25
AN5784	1"	1/8"	1-1/2"	100	AN5784-P	4	25
AN5785	1-1/4"	5/32"	1-3/4"	50	----	---	---
AN5786	1-1/2"	5/32"	2-1/8"	50	----	---	---

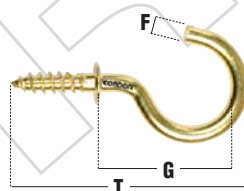

## CROCHET À VIS "M"

## SCREW HOOK "M"

Fini plaqué zinc poli.

NOUVEL EMBALLAGE / NEW PACK

Bright zinc plated finish

Numéro produit avec code à barres sur l'emballage Product number with bar code on the pack	No. produit avec code à barres Product no. with bar code	F	T	Emb. en vrac Pack in bulk	Emb. en "BC" Pack in "BC"	Numéro produit en sac poly avec code à barres P-pack Product number poly bag with bar code	Qté / sac Qty / Bag	Sacs / Bte Bags / Box
		Diamètre fil Wire diameter po. / in.	Longueur Length po. / in.					
AN5702	----	3/32"	1-3/8"	100	---	----	---	---
AN5704	----	3/32"	1-5/8"	100	---	AN5704-P	8	20
AN5706	----	1/8"	1-7/8"	100	---	AN5706-P	6	20
AN5708	----	5/32"	2-1/4"	100	---	AN5708-P	6	20
AN5710	AN5710BC	3/16"	2-3/4"	100	20	----	---	---
AN5712	AN5712BC	7/32"	3-1/4"	100	20	----	---	---
AN5714	AN5714BC	1/4"	3-3/4"	50	20	----	---	---
AN5716	AN5716BC	9/32"	4-1/4"	50	20	----	---	---
AN5718	AN5718BC	9/32"	4-1/2"	50	20	----	---	---
AN5720	AN5720BC	5/16"	4-1/2"	50	20	----	---	---

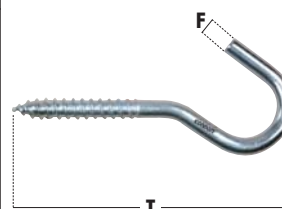

## CROCHET DE CORNICHE

## CORNICE HOOK

Fini plaqué zinc poli.

NOUVEL EMBALLAGE / NEW PACK

Bright zinc plated finish.

Numéro produit avec code à barres sur l'emballage Product number with bar code on the pack	F	T	Emb. Pack	Numéro produit en sac poly avec code à barres P-pack Product number poly bag with bar code	Qté / sac Qty / Bag	Sacs / Bte Bags / Box
	Diamètre fil Wire diameter po. / in.	Longueur Length po. / in.				
AN5732	1/8"	1-1/4"	100	AN5732-P	10	20
AN5735	1/8"	1-1/2"	100	AN5735-P	10	20
AN5737	5/32"	2"	100	AN5737-P	10	20
AN5740	3/16"	3"	100	AN5740-P	10	20



# Attaches, fils & toiles métalliques / Wire goods & fasteners

## FIL MÉTALLIQUE FLEXIBLE

Avec dévidoir. Avec étiquette code à barres.

Numéro produit Product number	Jauge Gauge	Longueur Length		Boîte Box	Emb. Pack
		m	pi. / ft.		
1511-19	19	50	164'	10	1



1511-19



## GALVANIZED WIRE

With dispenser.  
With bar code sticker.

## FIL MÉTALLIQUE TOUT USAGE

Tout usage, galvanisé, anti-rouille.

Fil flexible résistant sur présentoir de carton avec code à barres.

462-14	14	58'	10	1
462-16	16	95'	10	1
462-18	18	166'	10	1



## GENERAL PURPOSE WIRE

All purpose, galvanized,  
rust resistant. Pliable strong wire.  
Display card with bar code.

462



## FIL ACIER ARMATURE

Fil recuit de calibre 16 GA, en rouleaux compacts.

Avec étiquette code à barres.

Numéro produit Product number	Longueur Length		Poids / Rouleau Weight / Roll	Poids / Carton Weight / Carton	Boîte Box	Emb. Pack
	pi. / ft.	m	lb	lb		
ASWG16	394'	120	3-1/8	50	16 rl	1 rl



ASWG16



## IRON WIRE

Black annealed 16 GA, rebar tie  
wire coil to fit STD tie wire reel.  
With bar code sticker.

## BROCHE À COLLET EN LAITON

En sac poly, avec étiquette code à barres.

Numéro produit Product number	Jauge Gauge	Longueur Length pi. / ft.	Rouleau Coil oz	Boîte Box	Emb. Pack



P798



## BRASS SNARE WIRE

In poly bag.  
With bar code sticker.

## BROCHE À POULES

Galvanisée, hexagonale.

Numéro produit Product number	G Maille / Mesh	Largeur Width	Pieds / Rouleau Feet / Reel	Calibre Gauge
	po. / in.			
PLT2425	1"	24"	25'	22
PLT3625	1"	36"	25'	22
PLT4825	1"	48"	25'	22
PLT2450	1"	24"	50'	22
PLT3650	1"	36"	50'	22
PLT4850	1"	48"	50'	22
PLT24150	1"	24"	150'	22
PLT36150	1"	36"	150'	22
PLT48150	1"	48"	150'	22
PLT60100	1"	60"	100'	22
PLT72100	1"	72"	100'	22

NOUVEAU / NEW

## POULTRY NETTING

Galvanized, hexagonal.

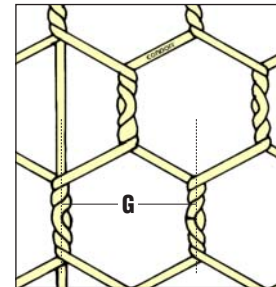

PLT



## TOILE MÉTALLIQUE

Galvanisée.

HCL03-36	1/8"	36"	50'	27
HCL06-10	1/4"	36"	10'	23
HCL06-24	1/4"	24"	50'	23
HCL06-30	1/4"	30"	50'	23
HCL06-36	1/4"	36"	50'	23
HCL10-10	3/8"	36"	10'	21
HCL10-36	3/8"	36"	50'	21
HCL13-10	1/2"	36"	10'	20
HCL13-24	1/2"	24"	50'	20
HCL13-30	1/2"	30"	50'	20
HCL13-36	1/2"	36"	50'	20
HCL13-48	1/2"	48"	50'	20
HCL19-36	3/4"	36"	100'	19
HCL25-36	1"	36"	100'	19

NOUVEAU / NEW

NOUVEAU / NEW

NOUVEAU / NEW

## HARDWARE CLOTH

Galvanized.

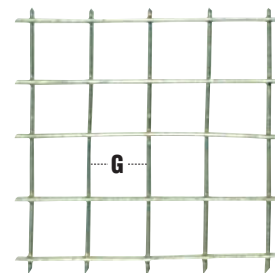

HCL

