



DESCRIPTION	PAGE
BAR HOLDER	
Bar Holder	50-23
BARREL BOLT	
Barrel Bolt	50-24
Solid Brass Barrel Bolt	50-24
Stainless Econo Barrel Bolt	50-24
BOLT	
Cane Bolt	50-02
Chain Bolt	50-25
Door Flushbolt	50-21
Heavy Duty Tower Bolt	50-24
Padbolt	50-25
Heavy Duty Padbolt	50-25
Stainless Steel Padbolt	50-25
Window Bolt	50-24
CASTER	
Furniture Caster	50-32
Industrial Caster	50-32
CATCH	
Adjustable Ball Catch	50-17
Adjustable Roller Catch	50-16
Double Ball Catch	50-18
Double Roller Cabinet Catch	50-18
Magnetic Catch	50-18
Screen Door Catch	50-05
Transom Catch	50-21
CLOSET ROD	
Adjustable Closet Rod	50-30
Closet Rod Accessories	50-30
CORNER BRACE	
Corner Brace	50-27
Double Wide Corner Brace	50-27
Flat Corner Iron	50-28
H.D. Triangle Corner Brace	50-28
DISPLAY PANEL	
Wall Display Panel	50-31
DOOR CLOSER	
Door Closer	50-06
DOOR HARDWARE	
Screen Door Hardware Kit	50-05
DOOR HOLDER	
Door Holder	50-16,25
Floor Mount Door Holder	50-06,18
Magnetic Door Holder	50-18
Wall Mount Door Holder	50-06,18
DOOR STOP	
Chain Door Stop	50-06
Flexible Door Stop	50-17
Floor Angle Door Stop	50-18
Floor Door Stop	50-18
Hinge-Pin Door Stop	50-16
Rigid Door Stop	50-18
Rubber Door Wedge	50-18
Wall Door Stop	50-18

DESCRIPTION	PAGE
DOOR VIEWER	
Door Viewer	50-20
GATE HARDWARE	
Gate Hardware Kit	50-01,04
Anti-Sag Gate Hardware Kit	50-01
HANDLE	
Chest Handle	50-26
Heavy Duty Door Handle	50-26
HANDRAIL BRACKET	
Handrail Bracket	50-14
Heavy Duty Handrail Bracket	50-14
HASP	
Fix. Staple Dble Hinge Hasp	50-23
Fix. Staple Hinge Safe. Hasp	50-22
Fixed Staple Safety Hasp	50-22
Stainless Fix. Staple Saf. Hasp	50-22
Locking Hasp	50-23
Loose Stapl. H.D. Safe. Hasp	50-23
Steel Safety Hasp	50-22
Swivel Staple Safety Hasp	50-23
HINGE	
1/4" Radius 3" Butt Hinge	50-08
1/4" Radius 3-1/2" Butt Hing.	50-09-11
1/4" R. Adjust. Spring Hinge	50-11
3-Leaf Hinge	50-12
5/8" Radius 3" Butt Hinge	50-08,10
5/8" Radius 3-1/2" Butt Hing.	50-09-10
Adjustable Spring Hinge	50-05,11
Back Flap Hinge	50-12
Butt Ball Bearing Hinge	50-11
Cafe Door Hinge	50-12
Double Acting Hinge	50-12
Fixed Pin Narrow Butt Hinge	50-13
Heavy Strap Hinge	50-04
Heavy T-Hinge	50-04
Light Strap Hinge	50-12
Light T-Hinge	50-12
Ornamental Cabinet Hinge	50-12
Ornamental Spring T-Hinge	50-03
Ornamental T-Hinge	50-03
Continuous (Piano) Hinge	50-07
S.S. Continuous (Piano) Hinge	50-07
Remov. Pin Narro. Butt Hing.	50-13
Rnd/Sq. Combin. Butt Hinge	50-08,10
Spring Hinge	50-05,11
Light Duty Spring Hinge	50-05
Square 3" Butt Hinge	50-08,10
Square 3-1/2" Butt Hinge	50-09-11
Square 4" Butt Hinge	50-10-11
Square Adjust. Spring Hinge	50-11
Stainless H.D. Strap Hinge	50-04
Stainless H.D. T-Hinge	50-04
Stain. Remov. Pin Narr. Hing.	50-13
Stainless Square Butt Hinge	50-10

DESCRIPTION	PAGE
HOOK	
Double Wardrobe Hook	50-15
Hat & Coat Hook	50-14-15
Single Wardrobe Hook	50-15
Storage Hook	50-31
LATCH	
Cup Board Latch	50-21
Gate Latch	50-01
Stainless Steel Gate Latch	50-01
Pool & Patio Latch	50-02
Slide Action Latch	50-01
Thumb Latch	50-02
Secret Gate Latch	50-21
Security Latch	50-20
LOCK	
Cam Lock	50-19
Casement Window Lock	50-21
Chain Door Guard	50-20
Letter Box Lock	50-19
Locking Chain Door Guard	50-20
Sash Lock	50-20-21
Security Spring Lock	50-25
PADLOCK	
Solid Brass Padlock	50-19
PLATE	
Double Wide Mending Plate	50-28
Kick Plate	50-06
Mending Plate	50-28
Push Plate	50-06
T-Plate	50-28
PULL	
Door Pull	50-06,26
Stainless Steel Door Pull	50-26
Door Pull & Plate	50-06
Garage Door Pull	50-26
Ornamental Gate Pull	50-02
Screen Door Pull	50-26
Stainless Steel Screen Door Pull	50-26
RING	
Trap Door Ring	50-26
SHELF BRACKET	
Folding Shelf Bracket	50-29
Ornamental Shelf Bracket	50-29
Shelf Bracket	50-29
Shelf & Rod Support	50-29
SPRING	
Door Spring	50-02
Gate Spring	50-02
STORAGE BIN	
Storage Bin	50-31
TURNTABLE	
Lazy Susan Turntable	50-07
WING TURN BUTTON	
Wing Turn Button	50-05

ALPHANUMERIC INDEX BY PAGE

Item 7 74470

PAGE 50-01



GATE HARDWARE

C278BLR	51452 6
C278GAR	51705 3
C278SSR	51277 5
C278WR	51278 2
C278ZR	51456 4
SH33189R	50396 4
SH33194R	50400 8
SH33198R	50404 6
SH33221R	50405 3

Item 7 74470

PAGE 50-02



SCREEN DOOR HARDWARE

C637M10	50348 3
C637M8	50468 8
SH33124BL	51712 1
SH33124Z	51284 3
SH33124BLR	51283 6
SH33124ZR	51882 1
SH33181R	50389 6
SH33182R	50390 2
SH33192R	50398 8
SH33195R	50401 5
SH33196R	50402 2
SH33197R	50403 9

Item 7 74470

PAGE 50-03



GATE HARDWARE

SH33183R	50391 9
SH33185R	50393 3

Item 7 74470

PAGE 50-04



GATE HARDWARE

SH209GAU	51469 4
SH209PB	50280 6
SH209ZU	50950 8
SH210ZU	51440 3
SH211GAU	51470 0
SH211PB	50109 0
SH211ZU	50951 5
SH212GAU	51471 7
SH212PB	50110 6
SH212ZU	50952 2
SH213GAU	51499 1
SH213PB	50254 7
SH213ZU	50953 9
SH214ZU	50954 6
SH215GAU	51472 4
SH215PB	50111 3
SH215ZU	50955 3
SH216ZU	51356 7
SH217GAU	51473 1
SH217PB	50112 0
SH217ZU	50956 0
SH218GAU	51474 8

Item 7 74470

SH218PB	50257 8
SH218ZU	50957 7
SH219PB	50259 2
SH219ZU	50958 4
SH220ZU	50959 1
3000BLR	51300 0
3000GAR	51503 5
3000WR	51704 6
3000ZR	51299 7
SH209SSUR	51289 8
SH211SSUR	51290 4
SH215SSUR	51291 1
SH217SSUR	51292 8

Item 7 74470

PAGE 50-05



SCREEN DOOR HARDWARE

C960BL	51362 8
C960W	51361 1
C960Z	51454 0
C961B	51180 8
C961Z	51182 2
C962BL	51365 9
C962Z	51366 6
MA100	50274 5
MAD550PVC	51411 3
MAD550Z	50598 2
MAD551PVC	51249 2
MAD551Z	51250 8
C960BLR	51305 5
C960WR	51304 8
C960ZR	51307 9
C961BR	51359 8
C961ZR	51360 4
C962BLR	51309 3
C962ZR	51308 6
C965BLR	51314 7
C965WR	51315 4
C965ZR	51312 3
MA100R	51570 7
MAD550PVC	51251 5
MAD550ZR	51799 2
MAD551PVC	51412 0
MAD551ZR	51879 1

Item 7 74470

PAGE 50-06



DOOR HARDWARE

732	50107 6
C1411	50136 6
C1412	50137 3
C1413	50138 0
C1416AL	50139 7
C1417AL	50140 3
C150830AL	50141 0
C150832AL	50802 0
C150834AL	50142 7
C151030AL	50143 4
C151032AL	50803 7
C151034AL	50144 1
C4860	50703 0
C751AL	50704 7
C752AL	50705 4
C753AL	50706 1

Item 7 74470

C754AL	50707 8
C755AL	50708 5
CDC23D	50478 7
CDC24D	50479 4
732R	51798 5

Item 7 74470

PAGE 50-07



CONTINUOUS (PIANO) HINGE

567-12	50309 4
567-3	50310 0
567-4	50311 7
567-6	50312 4
C1116B	50162 5
C1116N	50225 7
C1116SS	50692 7
C112B	50164 9
C112N	50249 3
C112SS	50694 1
C114B	50163 2
C114N	50226 4
C114SS	50693 4
C2B	50224 0
C2N	50250 9
C2SS	50695 8
CRT1116B	50218 9
CRT1116N	50219 6
CRT112B	50220 2
CRT112N	50221 9
CRT114B	50222 6
CRT114N	50223 3

Item 7 74470

PAGE 50-08



HINGES

CH2026-3AB-P	51081 8
CH2026-3AN-P	51083 2
CH2026-3BL-P	51563 3
CH2026-3C3-P	51082 5
CH2026-3ORB-P	51084 9
CH2026-3SAC-P	51085 6
CH2026-3SC-P	51074 0
CH2026-3SN-P	51072 6
CH2027-3AB-P	51095 5
CH2027-3AN-P	51094 8
CH2027-3BL-P	51563 9
CH2027-3C3-P	51100 6
CH2027-3ORB-P	51096 2
CH2027-3SAC-P	51097 9
CH2027-3SC-P	51098 6
CH2027-3SN-P	51099 3
CH2027-3W-P	51912 5
CH2028-3AB-P	51108 2
CH2028-3AN-P	51109 9
CH2028-3BL-P	51513 4
CH2028-3C3-P	51114 3
CH2028-3ORB-P	51110 5
CH2028-3SAC-P	51111 2
CH2028-3SC-P	51112 9
CH2028-3SN-P	51113 6
CH2029-3AB-P	51121 1
C751AL	50704 7
C752AL	50705 4
C753AL	50706 1

Item 7 74470

CH2029-3ORB-P	51117 4
CH2029-3SAC-P	51115 0
CH2029-3SC-P	51120 4
CH2029-3SN-P	51119 8
CH2026-3ABR	51656 8
CH2026-3ANR	51657 5
CH2026-3BLR	51836 4
CH2026-3C3R	51658 2
CH2026-3ORB	51655 1
CH2026-3SACR	51659 9
CH2026-3SCR	51660 5
CH2026-3SNR	51661 2
CH2027-3ABR	51669 8
CH2027-3ANR	51670 4
CH2027-3BLR	51334 5
CH2027-3C3R	51654 4
CH2027-3ORB	51671 1
CH2027-3SACR	51672 8
CH2027-3SCR	51673 5
CH2027-3SNR	51674 2
CH2027-3WR	51189 1
CH2028-3ABR	51682 7
CH2028-3ANR	51683 4
CH2028-3BLR	51684 1
CH2028-3C3R	51685 8
CH2028-3ORB	51686 5
CH2028-3SACR	51687 2
CH2028-3SCR	51688 9
CH2028-3SNR	51689 6
CH2029-3ABR	51697 1
CH2029-3ANR	51698 8
CH2029-3BLR	51800 5
CH2029-3C3R	51699 5
CH2029-3ORB	51700 8
CH2029-3SACR	51701 5
CH2029-3SCR	51702 2
CH2029-3SNR	51703 9

Item 7 74470

PAGE 50-09



HINGES

CH2027-35AB-P	51087 0
CH2027-35AN-P	51088 7
CH2027-35BL-P	51564 6
CH2027-35C3-P	51093 1
CH2027-35ORB-P	51089 4
CH2027-35SAC-P	51090 0
CH2027-35SC-P	51092 4
CH2027-35SN-P	51091 7
CH2027-35W-P	51913 2
CH2028-35AB-P	51101 3
CH2028-35AN-P	51102 0
CH2028-35BL-P	51514 1
CH2028-35C3-P	51107 5
CH2028-35ORB-P	51103 7
CH2028-35SAC-P	51104 4
CH2028-35SC-P	51105 1
CH2028-35SN-P	51106 8
CH2029-35AB-P	51128 0
CH2029-35AN-P	51123 5
CH2029-35BL-P	51744 2
CH2029-35C3-P	51125 9
CH2029-35ORB-P	51124 2
CH2029-35SAC-P	51122 8
CH2029-35SC-P	51127 3

Item 7 74470

CH2029-35SN-P	51126 6
CH2027-35ABR	51662 9
CH2027-35ANR	51663 6
CH2027-35BLR	51333 8
CH2027-35C3R	51664 3
CH2027-35ORB	51665 0
CH2027-35SACR	51666 7
CH2027-35SCR	51667 4
CH2027-35SNR	51668 1
CH2027-35WR	51190 7
CH2028-35ABR	51675 9
CH2028-35ANR	51676 6
CH2028-35BLR	51835 7
CH2028-35C3R	51677 3
CH2028-35ORB	51678 0
CH2028-35SACR	51679 7
CH2028-35SCR	51680 3
CH2028-35SNR	51681 0
CH2029-35ABR	51690 2
CH2029-35ANR	51691 9
CH2029-35BLR	51839 5
CH2029-35C3R	51692 6
CH2029-35ORB	51693 3
CH2029-35SACR	51694 0
CH2029-35SCR	51695 7
CH2029-35SNR	51696 4

Item 7 74470

PAGE 50-10



HINGES

1805ZU-2	50940 9
1805ZU-25	50941 6
1805ZU-3	50942 3
1805ZU-35	50943 0
1805ZU-4	50944 7
C1805-25	50470 1
C1805-3	50471 8
C1805-35	50472 5
C1805-4	50363 6
C1805Z-2	50949 2
C1805Z-25	50486 2
C1805Z-3	50487 9
C1805Z-35	50488 6
C1805Z-4	50489 3
CH2027-35SS	51348 2
CH2027-3SS	51347 5
CH2027-4C3	50197 7
CH2027N-4BL	51355 0
CH2027N-4SS	51349 9
CH2027N-4W	51352 9
CH2027-35SSR	51172 3
CH2027-3SSR	51171 6
CH2027N-4BLR	51336 9
CH2027N-4SSR	51173 0
CH2027N-4WR	51335 2

PAGE 50-11



HINGES

C179C15454	50253 0
C4027-35C3	51730 5
C4027-35SC	51731 2
C4027-35SN	51732 9
C4029-35C3	51733 6

Item 7 74470

C4029-35SC	51734 3
C4029-35SN	51735 0
C4029-4C3	51736 7
C4029-4SC	51737 4
C4029-4SN	51738 1
C4310C26D35	50712 2
C4310C26D44	50713 9
C4310C26D454	50714 6
C4310C435	50709 2
C4310C444	50710 8
C4310C4454	50711 5
CB848C1533	50669 9
CB848C1535	50670 5
CB848C1544	50671 2
CB848C1545	50672 9
CB848SDB33	50299 8
CB848SDB35	50190 8
CB848SDB44	50191 5
CB848SDB45	50192 2
C4027-35C3R	51184 6
C4027-35SCR	51185 3
C4027-35SNR	51186 0
C4029-35C3R	51261 4
C4029-35SCR	51263 8
C4029-35SNR	51264 5
C4029-4C3R	51262 1
C4029-4SCR	51266 9
C4029-4SNR	51265 2

Item 7 74470

PAGE 50-12



HINGES

752L2	51749 7
752L3	51750 3
752L4	51751 0
752L5	51752 7
752L6	51753 4
753L2	51754 1
753L3	51755 8
753L4	51756 5
753L5	51757 2
753L6	51758 9
C130B	50356 8
C2090-3BL	50159 5
C2090-4BL	50160 1
C2090-5BL	50272 1
C2090-6BL	50161 8
C3000	50691 0
C400-1	50666 8
C400-125	50610 1
C400-15	50611 8
C400-2	50665 1
C401B075	51205 8
C401B1	51206 5
C130BR	51768 8
C3000R	51763 3
C400-125R	51765 7
C400-15R	51766 4
C400-1R	51764 0
C400-2R	51767 1
C401B075R	51377 2
C401B1R	51378 9

Technical specifications are subject to change without prior notice

condor is a registered trademark of Canada-Europe Ltd.

Representation or reproduction of this document in any form or by any means is strictly prohibited.

ALPHANUMERIC INDEX BY PAGE

F: 1.855.329.8181 T: 1.800.363.9994

Item 7 74470 PAGE 50-13



HINGES

6021B-1	50425 1
6021B-15	50426 8
6021B-2	50427 5
6021B-25	50428 2
6021B-3	50429 9
6021RB-1	51272 0
6021RB-15	51273 7
6021RB-2	51274 4
6021RB-25	51275 1
6021RB-3	51276 8
6021RSS-2	51746 6
6021RZ-1	51267 6
6021RZ-15	51268 3
6021RZ-2	51269 0
6021RZ-25	51270 6
6021RZ-3	51271 3
6021Z-1	50481 7
6021Z-15	50482 4
6021Z-2	50483 1
6021Z-25	50484 8
6021Z-3	50485 5
6021B-15-P	50154 0
6021B-1-P	50153 3
6021B-25-P	50156 4
6021B-2-P	50155 7
6021B-3-P	50157 1
6021RB-15-P	51338 3
6021RB-1-P	51337 6
6021RB-25-P	51339 0
6021RB-2-P	51340 6
6021RB-3-P	51341 3
6021RSS-2-P	51357 4
6021RZ-15-P	51342 0
6021RZ-1-P	51343 7
6021RZ-25-P	51344 4
6021RZ-2-P	51345 1
6021RZ-3-P	51346 8
6021Z-15-P	50495 4
6021Z-1-P	50494 7
6021Z-25-P	50497 8
6021Z-2-P	50496 1
6021Z-3-P	50498 5
6021B-15R	51807 4
6021B-1R	51806 7
6021B-25R	51809 8
6021B-2R	51808 1
6021B-3R	51810 4
6021RB-15R	51817 3
6021RB-1R	51816 6
6021RB-25R	51819 7
6021RB-2R	51818 0
6021RB-3R	51820 3
6021RSS-2R	51762 6
6021RZ-15R	51812 8
6021RZ-1R	51811 1
6021RZ-25R	51814 2
6021RZ-2R	51813 5
6021RZ-3R	51815 9
6021Z-15R	51802 9
6021Z-1R	51801 2
6021Z-25R	51804 3

Item 7 74470 PAGE 50-14



FINISHING HARDWARE

6021Z-2R	51803 6
6021Z-3R	51805 0
C6280AB	50995 9
C6280AN	50996 6
C6280B	50562 3
C6280BL	51556 1
C6280CH	50563 0
C6280ORB	50998 0
C6280SAC	50999 7
C6280SC	51000 9
C6280SN	51001 6
C6280W	51210 2
C690AB	50519 7
C690AN	51003 0
C690B	50059 8
C690BL	51568 4
C690CH	51748 0
C690ORB	51005 4
C690SAC	51006 1
C690SC	51007 8
C690SN	51008 5
C690W	50845 7
C695B	50847 1
C6280ABR	51579 0
C6280ANR	51575 2
C6280BLR	51582 0
C6280BR	51576 9
C6280CHR	51580 6
C6280ORBR	51572 1
C6280SACR	51574 5
C6280SCR	51578 3
C6280SNR	51577 6
C6280WR	51581 3
C690ABR	51633 9
C690ANR	51632 2
C690BLR	51631 5
C690BR	51630 8
C690CHR	51629 2
C690ORBR	51628 5
C690SACR	51627 8
C690SCR	51626 1
C690SNR	51625 4
C690WR	51624 7
C695BR	51583 7
C6211AB	50981 2
C6211AN	50982 9
C6211B	50560 9
C6211BL	51555 4
C6211CH	50561 6
C6211ORB	50984 3
C6211SAC	50985 0
C6211SC	50986 7
C6211SN	50987 4
C6211W	51207 2
C6212AB	50988 1
C6212AN	50989 8

Item 7 74470 PAGE 50-15



FINISHING HARDWARE

C6212B	50564 7
C6212BL	51569 1
C6212CH	50565 4
C6212ORB	50991 1
C6212SAC	50992 8
C6212SC	50993 5
C6212SN	50994 2
C6212W	51208 9
C6213AB	51138 9
C6213AN	51133 4
C6213B	50566 1
C6213BL	51528 8
C6213CH	50567 8
C6213ORB	51134 1
C6213SAC	51132 7
C6213SC	51137 2
C6213SN	51136 5
C6213W	51209 6
C6211ABR	51775 6
C6211ANR	51771 8
C6211BLR	51778 7
C6211BR	51772 5
C6211CHR	51776 3
C6211ORBR	51769 5
C6211SACR	51770 1
C6211SCR	51774 9
C6211SNR	51773 2
C6211WR	51777 0
C6212ABR	51653 7
C6212ANR	51652 0
C6212BLR	51651 3
C6212BR	51650 6
C6212CHR	51649 0
C6212ORBR	51648 3
C6212SACR	51647 6
C6212SCR	51646 9
C6212SNR	51645 2
C6212WR	51644 5
C6213ABR	51643 8
C6213ANR	51642 1
C6213BLR	51641 4
C6213BR	51640 7
C6213CHR	51639 1
C6213ORBR	51638 4
C6213SACR	51637 7
C6213SCR	51636 0
C6213SNR	51635 3
C6213WR	51634 6
6034B	50600 2
C16AB	50974 4
C16AN	50975 1
C16B	50976 8
C16BL	51541 7
C16ORB	50977 5
C16SAC	50978 2
C16SC	50979 9
C16SN	50980 5
C17B	50599 9
C17REP	50677 4
C17SC	51467 0
C804B	51080 1

Item 7 74470 PAGE 50-16



FINISHING HARDWARE

C806AB	51009 2
C806AN	51010 8
C806B	51011 5
C806BL	51566 0
C806CH	51158 7
C806ORB	51012 2
C806SAC	51013 9
C806SC	51014 6
C806SN	51015 3
C806W	51191 4
C16ABR	51591 2
C16ANR	51587 5
C16BLR	51592 9
C16BR	51588 2
C16ORBR	51585 1
C16SACR	51586 8
C16SCR	51590 5
C16SNR	51589 9
C17REPR	51779 4
C806ABR	51786 2
C806ANR	51782 4
C806BLR	51789 3
C806BR	51783 1
C806CHR	51787 9
C806ORBR	51780 0
C806SACR	51781 7
C806SCR	51785 5
C806SNR	51784 8
C806WR	51788 6
6035AB	51722 0
6035AN	51724 4
6035B	51562 2
6035BL	51719 0
6035CH	51559 2
6035ORB	51720 6
6035SAC	51557 8
6035SC	51558 5
6035SN	51560 8
MA1602AB	50837 2
MA1602AN	51059 7
MA1602B	50438 1
MA1602BL	51542 4
MA1602N	50440 4
MA1602ORB	51063 4
MA1602SAC	51064 1
MA1602SC	51130 3
MA1602SN	51129 7
MA1602W	50846 4
MA1603AB	51065 8
MA1603AN	51066 5
MA1603B	51067 2
MA1603BL	51518 9
MA1603ORB	51068 9
MA1603SAC	51069 6
MA1603SC	51070 2
MA1603SN	51071 9
MA1603W	51196 9
6035ABR	51840 1
6035ANR	51841 8
6035BLR	51842 5
6035BR	51843 2

Item 7 74470 PAGE 50-17



DOOR HARDWARE

6035CHR	51844 9
6035ORBR	51845 6
6035SACR	51846 3
6035SCR	51847 0
6035SNR	51848 7
MA1602ABR	51797 8
MA1602ANR	51792 3
MA1602BLR	51822 7
MA1602BR	51793 0
MA1602NR	51796 1
MA1602ORBR	51790 9
MA1602SACR	51791 6
MA1602SCR	51795 4
MA1602SNR	51794 7
MA1602WR	51821 0
MA1603ABR	51608 7
MA1603ANR	51607 0
MA1603BLR	51606 3
MA1603BR	51605 6
MA1603ORBR	51604 9
MA1603SACR	51603 2
MA1603SCR	51602 5
MA1603SNR	51601 8
MA1603WR	51600 1
724	50020 8
725	50021 5
C3631C2G	50337 7
CB175SB	50808 2
CB2SB	50809 9
CM1450WS	50212 7
CM1560W	50661 3
CT200B	51450 2
CT200SC	51451 9
CT218B	51448 9
CT218SC	51449 6
CT231B	51489 2
CT231SC	51447 2
CT233B	51610 0
CT233SC	51446 5
CT234W	51203 4
DW150	50684 2
MA1604B	50441 1
MH401PVC	51911 8
CT200BR	51617 9
CT200SCR	51616 2
CT231BR	51613 1
CT231SCR	51612 4
CT233BR	51611 7
CT233SCR	51609 4
CT234WR	51391 8
DW150R	51823 4
MA1604BR	51622 3
MH401PVC	50686 6
C261KD	50696 5
C262KD	50697 2
C263KD	50698 9

Item 7 74470 PAGE 50-18



DOOR HARDWARE

C264KD	50699 6
C265KD	50800 6
C500-23KD	50342 1
C500-30KD	50343 8
C831KA	51160 0
C831KD	50346 9
C832KA	51162 4
C832KD	51161 7
C833KA	51164 8
C833KD	51163 1
C834KA	51166 2
C834KD	51165 5
C835KA	51168 6
C835KD	51167 9
C836KA	51170 9
C836KD	50352 0
PB630B1	51888 3
PB630B125	51889 0
PB630B15	51890 6
PB630B2	51891 3
C831KDR	51863 0
C832KDR	51865 4
C833KDR	51867 8
C834KDR	51869 2
C835KDR	51871 5
C836KDR	51873 9
LB284BR	50076 5
PB630B125R	50629 3
PB630B15R	50630 9
PB630B1R	50628 6
PB630B2R	50632 3
C2833B	50636 1
C2833W	51255 3
C811B	51383 3
C811SC	51384 0
C812B	51211 9
C812SC	51212 6
C813AB	51016 0
C813AN	51017 7
C813B	51018 4
C813BL	51567 7
C813ORB	51019 1
C813SAC	51020 7
C813SC	51021 4
C813SN	51022 1
CB02B	50806 8
CB02SN	51741 1
CB03B	50807 5
CB03SN	51742 8
C2833BR	51826 5
C2833WR	51414 4
C811BR	51213 3
C811SCR	51381 9
C812BR	51379 6
C812SCR	51380 2
C813ABR	51598 1
C813ANR	51595 0
C813BLR	51599 8
C813BR	51824 1
C813ORBR	51593 6
C813SACR	51594 3

Item 7 74470 PAGE 50-20



SECURITY

ALPHANUMERIC INDEX BY PAGE

Item	7 74470
C813SCR	51597 4
C813SNR	51596 7
CB02BR	51874 6
CB02SNR	51875 3
CB03BR	51876 0
CB03SNR	51877 7

PAGE 50-21



SECURITY

C2831B	50474 9
C2832B	50634 7
C504B30	51258 4
C5215SL	50475 6
C600N	50633 0
C81B	50476 3
CDC25SL	50635 4
C2831BR	51827 2
C2832BR	51825 8
C504B30R	51416 8
C5215SLR	51855 5
CDC25SLR	51878 4

PAGE 50-22



SECURITY

752H3	51477 9
752H45	51478 6
C34B2	50625 5
C34B25	50626 2
C34B3	50627 9
C61722	51328 4
C61723	50369 8
C617235	50370 4
C617245	50371 1
C61726	50372 8
C618BL45	51370 3
C618GA45	51504 2
C618SS45	51369 7
C61822	51759 6
C618225	51725 1
C618235	51220 1
C618245	51221 8
C61826	51222 5
752H3R	51849 4
752H45R	51851 7
C34B25R	51829 6
C34B2R	51828 9
C34B3R	51830 2
C618BL45R	51227 0
C618GA45R	51856 2
C618SS45R	51228 7
C618225R	51857 9
C61822R	51858 6
C618235R	51859 3
C618245R	51860 9
C61826R	51861 6

PAGE 50-23



SECURITY

710CH3	51739 8
710CH45	51740 4

Item	7 74470
756	51259 1
757	51260 7
C619H35	51224 9
C620BL8	51940 8
C620Z8	51321 5
C629Z35	51214 0
C629Z45	51215 7
710CH3R	50001 7
710CH45R	50077 2
C619H35R	51318 5
C620BL8R	51320 8
C620Z8R	51941 5
C629Z35R	51831 9
C629Z45R	51832 6

PAGE 50-24



SECURITY

C1061B100	51230 0
C1061B50	51231 7
C1061B64	51232 4
C1061B75	51233 1
C1061SS100	51372 7
C1061W50	51229 4
C1061Z100	50613 2
C1061Z125	50602 6
C1061Z150	50603 3
C1061Z50	50585 2
C1061Z64	50614 9
C1061Z75	50615 6
C161J25	50357 5
C161J3	50358 2
C161J4	50359 9
C161J5	50360 5
C161J6	50361 2
C1693B25	50616 3
C1693B3	50617 0
C1693B4	50362 9
C1693Z2	51331 4
C923A10	50375 9
C923A4	50376 6
C923A6	50377 3
C923A8	50378 0
BB15CHR	50096 3
BB15SBR	50095 6
BB20CHR	50098 7
BB20SBR	50097 0
BB25CHR	50100 7
BB25SBR	50099 4
BB30CHR	50102 1
BB30SBR	50101 4
BB40CHR	50307 0
BB40SBR	50326 1
C1061B100R	51903 3
C1061B50R	51900 2
C1061B64R	51901 9
C1061B75R	51902 6
C1061SS100R	51322 2
C1061W50R	51899 9
C1061Z100R	51907 1
C1061Z50R	51904 0
C1061Z64R	51905 7
C1061Z75R	51906 4
C1693B25R	51896 8
C1693B3R	51897 5

PAGE 50-25

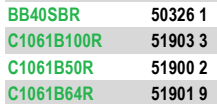

SECURITY

MA320-075C	50927 0
MA320-1	50480 0
MA320-15	50443 5
MA320-175C	50930 0
MA320-2	50444 2
MA320-25	50445 9
MA320-3	50446 6
MA320-35	50447 3
MA320-4	50448 0
MA320W-075C	50932 4

Item	7 74470
C1693B4R	51898 2
C1693Z2R	51895 1

PAGE 50-25



SECURITY

100A10	50702 3
100A6	50700 9
100A8	50701 6
100A-SS6	51939 2
C1014-02	50675 0
C1015-02	50676 7
C1067Z4	51234 8
C1067Z6	51235 5
C1068Z45	50596 8
C1068Z6	50597 5
C1166Z	51237 9
C1168Z	51374 1
C1166ZR	51854 8
C1168ZR	51236 2

PAGE 50-26



DOOR PULLS

2381BL55	51324 6
2381BL65	51246 1
2381CH3	50384 1
2381CH4	50385 8
2381CH5	50386 5
2381CH6	50387 2
2381GA65	51327 7
2381W65	51375 8
2381Z55	51242 3
2381Z65	51243 0
2381Z8	50664 4
C2151	50364 3
C2535	50365 0
C328Z	50333 9
CP475CH	50685 9
CP475SS	51367 3
2381BL55R	51894 4
2381BL65R	51707 7
2381GA65R	51887 6
2381SS65R	51376 5
2381W65R	51325 3
2381Z55R	51892 0
2381Z65R	51893 7
CP475CHR	51310 9
CP475SSR	51238 6

PAGE 50-27



CONSTRUCTION

MA320-075C	50927 0
MA320-1	50480 0
MA320-15	50443 5
MA320-175C	50930 0
MA320-2	50444 2
MA320-25	50445 9
MA320-3	50446 6
MA320-35	50447 3
MA320-4	50448 0
MA320W-075C	50932 4

Item	7 74470
MA320W-175C	50938 6
MA320-075-P	50926 3
MA320-10BC	51154 9
MA320-15BC	50721 4
MA320-175-P	50929 4
MA320-1BC	50720 7
MA320-25BC	50723 8
MA320-2BC	50722 1
MA320-35BC	50725 2
MA320-3BC	50724 5
MA320-4BC	50726 9
MA320-5BC	50450 3
MA320-6BC	50451 0
MA320-8BC	50452 7
MA320S-075BC	50931 7
MA320W-075-P	50934 8
MA320W-175-P	50939 3
MA323-15BC	51146 4
MA323-25BC	51148 8
MA323-2BC	51147 1

PAGE 50-28

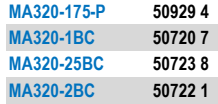

CONSTRUCTION

MA322-2	50461 9
MA322-25	50462 6
MA322-3	50463 3
MA321-15BC	50727 6
MA321-25BC	50729 0
MA321-2BC	50728 3
MA321-35BC	50731 3
MA321-3BC	50730 6
MA321-4BC	50732 0
MA321-5BC	50733 7
MA321-6BC	50734 4
MA322-10BC	51152 5
MA322-12BC	51153 2
MA322-25BC	50741 2
MA322-2BC	50740 5
MA322-3BC	50742 9
MA322-4BC	50735 1
MA322-5BC	50465 7
MA322-6BC	50466 4
MA322-8BC	50467 1
MA324-2BC	51149 5
MA324-3BC	51150 1
MA324-4BC	51151 8
MA325-25BC	50743 6
MA325-3BC	50744 3
MA325-4BC	50745 0
MA325-5BC	50746 7
MA355-15-P	51155 6
MA355-25-P	51156 3
MA355-35-P	51157 0

PAGE 50-29



STORAGE

21-1016	50841 9
21-1320	50842 6
21-812	50840 2
326-1012	50120 5
326-1214	50121 2
326-34	50122 9

Item	7 74470
326-45	50123 6
326-56	50124 3
326-68	50125 0
326-79	50126 7
326-810	50127 4
337-02	50579 1
337-06	50580 7
337-1012	50410 7
337-1214	50411 4
337-34	50412 1
337-45	50413 8
337-56	50414 5
337-68	50415 2
337-79	50416 9
337-810	50417 6
342BL-107	51436 6
342BL-53	51434 2
342BL-85	51435 9
342W-107	51439 7
342W-53	51437 3
342W-85	51438 0
436	50070 3
437	50071 0
438	50072 7
ST1000E	52102 9

PAGE 50-30



STORAGE

CR1000	51427 4
CR1000W	51397 0
CR1500	51424 3
CR1500W	51398 7
CR1501B	51428 1
CR1502W	51400 7
CR1830	51181 5
CR1830W	51401 4
CR3048	51301 7
CR3048W	51402 1
CR4872	51481 6
CR4872W	51403 8
CR7296	51721 3
CR7296W	51404 5
CR9612	51961 3
CR9612W	51405 2
CRF1830	51392 5
CRF1830W	51406 9
CRF3048	51393 2
CRF3048W	51407 6
CRF4872	51394 9
CRF4872W	51408 3
CRF7296	51395 6
CRF7296W	51409 0
CRF9612	51396 3
CRF9612W	51410 6
CR1000R	51837 1
CR1000WR	51425 0
CR1500R	51838 8
CR1500WR	51422 9
CR1501BR	51399 4
CR1502WR	51429 8

Item	7 74470
602P	30138 6
603P	30139 3
604P	30140 9
720M	30359 5
AN5250WBC	50970 6
AN5251RBC	50962 1
AN5252RBC	50963 8
AN5253RBC	50964 5
AN5255RBC	50965 2
AN5256RBC	50966 9
AN5257RBC	50967 6
AN5258RBC	50968 3
AN5259RBC	50969 0

PAGE 50-31

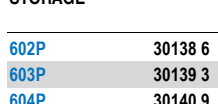

STORAGE

602P	30138 6
603P	30139 3
604P	30140 9
720M	30359 5
AN5250WBC	50970 6
AN5251RBC	50962 1
AN5252RBC	50963 8
AN5253RBC	50964 5
AN5255RBC	50965 2
AN5256RBC	50966 9
AN5257RBC	50967 6
AN5258RBC	50968 3
AN5259RBC	50969 0

PAGE 50-32



CASTERS

415ER2	50243 1
415ER25	50244 8
415ER3	50245 5
415ER4	50246 2
420B15	50247 9
420B2	50248 6
420G125	50227 1
420G15	50228 8
420G2	50229 5
420G25	50230 1
420G3	50231 8
420R125	50232 5
420R15	50233 2
420R2	50234 9
420R25	50235 6
420R3	50236 3
420R4	50237 0
420R5	50238 7
420R6	50239 4
420S4	50240 0
420S5	50241 7
420S6	50242 4

GATE HARDWARE

F: 1.855.329.8181 T: 1.800.363.9994

◇ breakable pack



CARDED



STAINLESS STEEL



CAN BE PADLOCKED

GATE LATCH

Can be padlocked

	F					
C278ZR	Zinc (C2G)	2"	1-3/8"	2-1/4"	10 ◇	51456 4
C278BLR	Epoxy Black	2"	1-3/8"	2-1/4"	10 ◇	51452 6
C278WR	White Enamelled	2"	1-3/8"	2-1/4"	10 ◇	51278 2
C278GAR	Galvanized	2"	1-3/8"	2-1/4"	10 ◇	51705 3

Available also as a set p.50-04

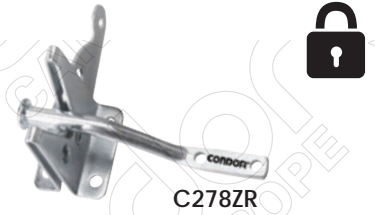

STAINLESS STEEL GATE LATCH

Can be padlocked

TYPE 304

	F						
C278SSR	Stainless Steel	2"	1-3/8"	2-1/4"	6 ◇	51277 5	



GATE HARDWARE KIT

Consists of one C278 gate latch and a pair of rectangular T-hinges
Epoxy black finish

SH33221R	4-1/2"	5"	1-11/16"	2-1/4"	4 st ◇	50405 3



HEAVY DUTY GATE LATCH

Used for stable door or double driveway gate
Can be padlocked
Epoxy black finish

SH33194R	1/2"	2-3/4"	4-3/16"	2-1/8"	2-7/8"	4 ◇	50400 8

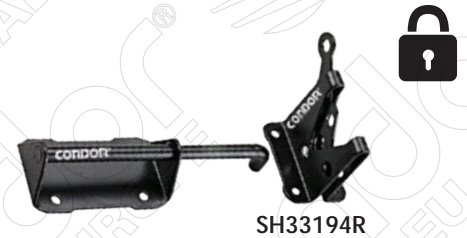

SLIDE ACTION LATCH

Used on doors and gates swinging in and out
Can be padlocked
Epoxy black finish

SH33189R	3/8"	2-3/8"	4-1/4"	6 ◇	50396 4



ANTI-SAG GATE HARDWARE KIT

Used for gate up to 6 ft x 4 ft, included two corner brackets, steel cable
1/8 in. x 90 in., two pairs of wire rope clips and one turnbuckle
Zinc plated

SH33198R	4 st ◇	50404 6	7 74470...

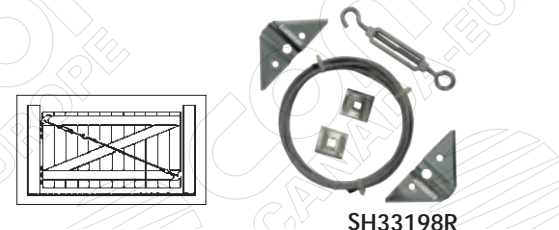



F: 1.855.329.8181 T: 1.800.363.9994

◇ breakable pack

GATE HARDWARE



7 74470 1 XXXXX X
FLAGGED



CARDED



CAN BE PADLOCKED



SH33195R

ORNAMENTAL GATE PULL

Epoxy black finish

SH33195R	10"	4 ◇	50401 5	7 74470...



SH33196R

ORNAMENTAL THUMB LATCH

Used on door opening one way only
Can be padlocked
Epoxy black finish

SH33196R	8"	4-3/16"	3"	4 ◇
				50402 2



SH33124Z

SH33124BL

THUMB LATCH

Used on door opening one way only
Can be padlocked

		F				
SH33124Z	Zinc (C2G)	10 ◇	51284 3	SH33124ZR	5 ◇	51882 1
SH33124BL	Black	10 ◇	51712 1	SH33124BLR	5 ◇	51283 6



SH33192R

POOL & PATIO LATCH

Used around pools where extra security is needed
Can be padlocked
Epoxy black finish

SH33192R	5/16"	5"	4 ◇	50398 8



SH33181R

CANE BOLT

For use on double gates garage and overhead doors
Epoxy black finish

SH33181R	1/2"	12"	4 ◇	50389 6
SH33182R	1/2"	18"	4 ◇	50390 2



SH33197R

GATE SPRING

Adjustable tension
Epoxy black finish

SH33197R	8"	13-3/4"	4 ◇	50403 9



C637M

DOOR SPRING

Adjustable tension
Epoxy black finish

C637M8		8"	10 ◇	50468 8
C637M10		10"	10 ◇	50348 3



CARDED BY PAIR



ORNAMENTAL T-HINGE

To be used for timber fencing, gates and exterior doors, for patios, sheds and "ranch" type houses
 Epoxy black finish

Packed by pair



Type



SH33183R

7-7/8"

8"

Spring action

4 pr ◇

20 ◇

50391 9

SH33185R

7-7/8"

8"

Regular action

4 pr ◇

20 ◇

50393 3



SH33183R



F: 1.855.329.8181 T: 1.800.363.9994

◇ breakable pack

GATE HARDWARE



HEAVY T-HINGE



SH211ZU

ZINC (C2G) PLATED
Individually packed



SH211GAU

GALVANIZED
Individually packed



SH211PB

EPOXY BLACK FINISH
Packed by pair



SH209ZU	20 un	◇	50950 8
SH210ZU	10 un	◇	51440 3
SH211ZU	10 un	◇	50951 5
SH212ZU	10 un	◇	50952 2
SH213ZU	10 un	◇	50953 9
SH214ZU	8 un	◇	50954 6



SH209GAU	20 un	◇	51469 4
---	---	---	---
SH211GAU	10 un	◇	51470 0
SH212GAU	10 un	◇	51471 7
SH213GAU	10 un	◇	51499 1

Solid brass pin



SH209PB	10 pr	◇	50280 6
---	---	---	---
SH211PB	5 pr	◇	50109 0
SH212PB	5 pr	◇	50110 6
SH213PB	5 pr	◇	50254 7

4"	1-3/8"	3-3/8"	0.09"
5"	1-1/2"	3-3/4"	0.10"
6"	1-7/8"	4-1/2"	0.10"
8"	2-3/8"	5-1/2"	0.10"
10"	2-3/8"	5-1/2"	0.11"
12"	2-1/2"	6"	0.11"

HEAVY STRAP HINGE



SH217ZU

ZINC (C2G) PLATED
Individually packed



SH217GAU

GALVANIZED
Individually packed



SH217PB

EPOXY BLACK FINISH
Packed by pair



SH215ZU	20 un	◇	50955 3
SH216ZU	10 un	◇	51356 7
SH217ZU	10 un	◇	50956 0
SH218ZU	10 un	◇	50957 7
SH219ZU	10 un	◇	50958 4
SH220ZU	8 un	◇	50959 1



SH215GAU	20 un	◇	51472 4
---	---	---	---
SH217GAU	10 un	◇	51473 1
SH218GAU	10 un	◇	51474 8

Solid brass pin



SH215PB	10 pr	◇	50111 3
---	---	---	---
SH217PB	5 pr	◇	50112 0
SH218PB	5 pr	◇	50257 8
SH219PB	5 pr	◇	50259 2

4"	1-5/8"	0.09"
5"	2"	0.10"
6"	2-1/2"	0.10"
8"	3"	0.10"
10"	3"	0.11"
12"	3-1/2"	0.11"

STAINLESS STEEL HEAVY DUTY HINGES

Individually packed



SH211SSUR

TYPE 304



SH217SSUR

T-HINGE

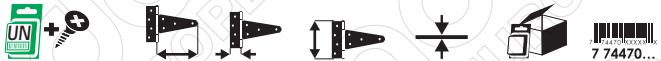

SH209SSUR	4"	1-3/8"	3-3/8"	0.09"	4 un	◇	51289 8
SH211SSUR	6"	1-7/8"	4-1/2"	0.10"	4 un	◇	51290 4

STRAP HINGE

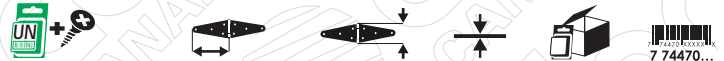

SH215SSUR	4"	1-5/8"	0.09"	4 un	◇	51291 1
SH217SSUR	6"	2-1/2"	0.10"	4 un	◇	51292 8

GATE HARDWARE KIT

Consists of one C278 gate latch,
a pair of 6" T-hinges & one 6-1/2" door pull

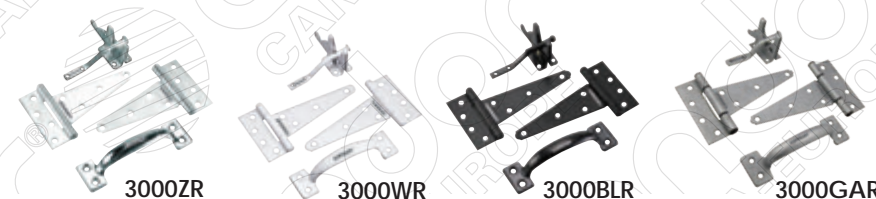

3000ZR	Zinc (C2G)	4 st	◇	51299 7
3000WR	White Enamelled	4 st	◇	51704 6
3000BLR	Epoxy Black	4 st	◇	51300 0
3000GAR	Galvanized	4 st	◇	51503 5

SCREEN DOOR HARDWARE

F: 1.855.329.8181 T: 1.800.363.9994
 ◇ breakable pack



7 74470 XXXXX 1 X



BAGGED BY PAIR



POLY BAGGED



CARDED BY PAIR



CARDED

SCREEN DOOR HARDWARE KIT

Included a pair of 2-1/2" spring hinges, a pair of 2-1/2" square butt hinges, a screen door catch, a 4-3/4" screen door handle and a 4" gate hook

	F		
C965ZR	Zinc (C2G)	5 st ◇	51312 3
C965BLR	Epoxy Black	5 st ◇	51314 7
C965WR	White Enamelled	5 st ◇	51315 4

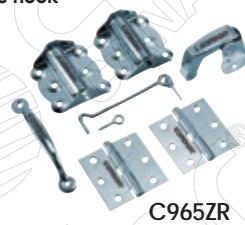

LIGHT DUTY SPRING HINGE

	F			
C961B	Bright Brass (C3)	2" 1-3/4"	10 pr ◇	51180 8
C961Z	Zinc (C2G)	2" 1-3/4"	10 pr ◇	51182 2

	F		
C961BR		12 pr ◇	51359 8
C961ZR		12 pr ◇	51360 4



SPRING HINGE

	F			
C960Z	Zinc (C2G)	2-3/4" 2-1/2"	10 pr ◇	51454 0
C960BL	Epoxy Black	2-3/4" 2-1/2"	10 pr ◇	51362 8
C960W	White Enamelled	2-3/4" 2-1/2"	10 pr ◇	51361 1

	F		
C960ZR		6 pr ◇	51307 9
C960BLR		6 pr ◇	51305 5
C960WR		6 pr ◇	51304 8



ADJUSTABLE SPRING HINGE

Packed by pair

Individually packed

	F			
C962Z	Zinc (C2G)	3" 3"	5 pr ◇	51366 6
C962BL	Epoxy Black	3" 3"	5 pr ◇	51365 9

	F		
C962ZR		5 un ◇	51308 6
C962BLR		5 un ◇	51309 3



SCREEN DOOR CATCH

Dual rollers & coil spring hold door securely

	F			
MA100	Zinc (C2G)	10 ◇	200 ◇	50274 5

	F		
MA100R		6 ◇	51570 7



WING TURN BUTTONS



TWO WINGS ZINC PLATED

	F			
MAD550Z	1-3/4" 4	25 (x4)	50598 2	

TWO WINGS ZINC PLATED

	F			
MAD550ZR	4	10 ◇ (x4)	51799 2	

TWO WINGS WHITE PLASTIC

	F			
MAD550PVC	8 25 (x8)	51411 3		

TWO WINGS WHITE PLASTIC

	F			
MAD550PVCR	8 10 ◇ (x8)	51251 5		

ONE WING ZINC PLATED

	F			
MAD551Z	1-1/4" 4	25 (x4)	51250 8	

ONE WING ZINC PLATED

	F			
MAD551ZR	4	10 ◇ (x4)	51879 1	

ONE WING WHITE PLASTIC

	F			
MAD551PVC	8 25 (x8)	51249 2		

ONE WING WHITE PLASTIC

	F			
MAD551PVCR	8 10 ◇ (x8)	51412 0		



F: 1.855.329.8181 T: 1.800.363.9994

◇ breakable pack

DOOR HARDWARE



LIGHT CHAIN DOOR STOP

Heavy zinc plated spring & chain, S-hook permits chain to be easily detached



732	26"	10 ◇	50107 6	732R	5 ◇	51798 5	7 74470...

HEAVY CHAIN DOOR STOP

Heavy welded zinc plated chain, grey vinyl covered, with two coil springs



C4860	25-1/2"	5 ◇	50703 0	7 74470...

DOOR CLOSER

Full size; universal application. Two separate adjustment valves for closing and latching speeds. Power adjustable forearm shoe. Narrow design die-cast aluminium housing. High quality rack and pignon mechanism. Up to 180° opening angle. Reversible, size 1 thru 5. Non-gumming, non-freezing all seasons hydraulic fluid UL & ULC listed, 5-year guarantee

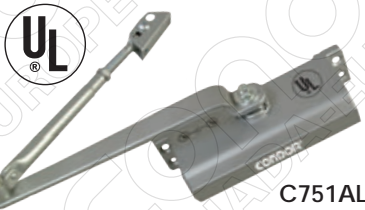

C751AL	33 - 80	7-1/8"	1	50704 7
C752AL	55 - 100	8-7/8"	1	50705 4
C753AL	90 - 145	8-7/8"	1	50706 1
C754AL	125 - 190	9-3/4"	1	50707 8
C755AL	175 - 265	9-3/4"	1	50708 5

DOOR PULL & PLATE

Satin aluminium finish

C1411	7"	3-1/2"	15"	1 st	50136 6

DOOR PULL

Satin aluminium finish

C1412	7"	10 ◇	50137 3	7 74470...
C1413	9"	10 ◇	50138 0	7 74470...

PUSH PLATE

Satin aluminium finish

C1416AL	3-1/2"	15"	10 ◇	50139 7
C1417AL	4"	16"	10 ◇	50140 3

KICK PLATE

Satin aluminium finish

C150830AL	8"	30-1/2"	10 ◇	50141 0
C150832AL	8"	32-1/2"	10 ◇	50802 0
C150834AL	8"	34-1/2"	10 ◇	50142 7
C151030AL	10"	30-1/2"	10 ◇	50143 4
C151032AL	10"	32-1/2"	10 ◇	50803 7
C151034AL	10"	34-1/2"	10 ◇	50144 1

DOOR HOLDERS

WALL MOUNT, FLOOR MOUNT

Nickel plated cast zinc

		Type				
CDC23D	Wall	---	2-1/2"	10 ◇	50478 7	7 74470...
CDC24D	Floor	1-3/4"	---	10 ◇	50479 4	7 74470...

PIANO HINGE

F: 1.855.329.8181 T: 1.800.363.9994
 ◇ breakable pack

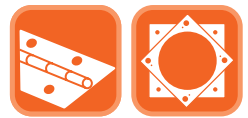

FLAGGED



STAINLESS STEEL



PIN DIAMETER



WORKING LOAD LIMIT

CONTINUOUS (PIANO) HINGE

NICKEL PLATED

CRT1116N	30"	1-1/16"	0.0669"	1/16"	10	50219 6	7 74470...	
CRT114N	30"	1-1/4"	0.0669"	1/16"	10	50223 3		
CRT112N	30"	1-1/2"	0.0669"	1/16"	10	50221 9		

NICKEL PLATED

C1116N	72"	1-1/16"	0.0669"	1/16"	10	50225 7	7 74470...	
C114N	72"	1-1/4"	0.0669"	1/16"	10	50226 4		
C112N	72"	1-1/2"	0.0669"	1/16"	10	50249 3		
C2N	72"	2"	0.0669"	1/16"	5 ◇	50250 9		

BRIGHT BRASS PLATED (C3)

CRT1116B	30"	1-1/16"	0.0669"	1/16"	10	50218 9	7 74470...	
CRT114B	30"	1-1/4"	0.0669"	1/16"	10	50222 6		
CRT112B	30"	1-1/2"	0.0669"	1/16"	10	50220 2		

BRIGHT BRASS PLATED (C3)

C1116B	72"	1-1/16"	0.0669"	1/16"	10	50162 5	7 74470...	
C114B	72"	1-1/4"	0.0669"	1/16"	10	50163 2		
C112B	72"	1-1/2"	0.0669"	1/16"	10	50164 9		
C2B	72"	2"	0.0669"	1/16"	5 ◇	50224 0		

STAINLESS STEEL CONTINUOUS (PIANO) HINGE

TYPE 304

C1116SS	72"	1-1/16"	0.042"	3/32"	10 ◇	50692 7	7 74470...		
C114SS	72"	1-1/4"	0.042"	3/32"	10 ◇	50693 4			
C112SS	72"	1-1/2"	0.042"	3/32"	10 ◇	50694 1			
C2SS	72"	2"	0.042"	3/32"	5 ◇	50695 8			

TURNTABLES LAZY SUSAN

Heavy steel, smooth turning on ball bearings

			Type					
567-3			Square	3"	---	200	10 ◇	50310 0
567-4			Square	4"	---	300	10 ◇	50311 7
567-6			Square	6"	---	500	10 ◇	50312 4
567-12			Round	---	12"	1,000	10 ◇	50309 4

MADE in Germany

MADE in Germany

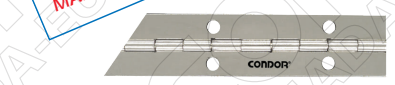
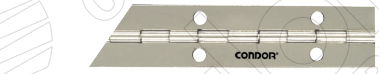

567-6

567-12

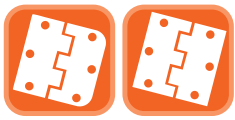

F: 1.855.329.8181 T: 1.800.363.9994



HINGES

◇ breakable pack



SQUARE BUTT HINGES

5/8" RADIUS & SQUARE COMBINATION BUTT HINGE

Full mortise, loose pin, swaged

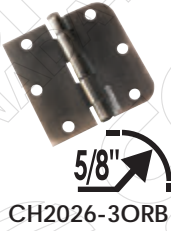

Individually packed

3-3/16" x 3"

CH2026-3ORB-P	Oil Rubbed Bronze (C10B)	12 un	96 un	◇	51084 9	
CH2026-3SAC-P	Satin Antique Copper (C12A)	12 un	96 un	◇	51085 6	
CH2026-3AN-P	Antique Nickel (C17A)	12 un	96 un	◇	51083 2	
CH2026-3C3-P	Bright Brass (C3)	12 un	96 un	◇	51082 5	
CH2026-3SN-P	Satin Nickel (C15)	12 un	96 un	◇	51072 6	
CH2026-3SC-P	Satin Chrome (C26D)	12 un	96 un	◇	51074 0	
CH2026-3AB-P	Antique Brass (C5)	12 un	96 un	◇	51081 8	
CH2026-3BL-P	Mat Black (C19)	12 un	96 un	◇	51565 3	

Individually packed

CH2026-3ORBR		8 un	◇	51655 1		
CH2026-3SACR		8 un	◇	51659 9		
CH2026-3ANR		8 un	◇	51657 5		
CH2026-3C3R		8 un	◇	51658 2		
CH2026-3SNR		8 un	◇	51661 2		
CH2026-3SCR		8 un	◇	51660 5		
CH2026-3ABR		8 un	◇	51656 8		
CH2026-3BLR		8 un	◇	51836 4		

SQUARE BUTT HINGE

Full mortise, loose pin, swaged



Individually packed

3" x 3"

CH2027-3ORB-P	Oil Rubbed Bronze (C10B)	12 un	96 un	◇	51096 2	
CH2027-3SAC-P	Satin Antique Copper (C12A)	12 un	96 un	◇	51097 9	
CH2027-3AN-P	Antique Nickel (C17A)	12 un	96 un	◇	51094 8	
CH2027-3C3-P	Bright Brass (C3)	12 un	96 un	◇	51100 6	
CH2027-3SN-P	Satin Nickel (C15)	12 un	96 un	◇	51099 3	
CH2027-3SC-P	Satin Chrome (C26D)	12 un	96 un	◇	51098 6	
CH2027-3AB-P	Antique Brass (C5)	12 un	96 un	◇	51095 5	
CH2027-3BL-P	Mat Black (C19)	12 un	96 un	◇	51563 9	
CH2027-3W-P	White	12 un	96 un	◇	51912 5	

Individually packed

CH2027-3ORBR		8 un	◇	51671 1		
CH2027-3SACR		8 un	◇	51672 8		
CH2027-3ANR		8 un	◇	51670 4		
CH2027-3C3R		8 un	◇	51654 4		
CH2027-3SNR		8 un	◇	51674 2		
CH2027-3SCR		8 un	◇	51673 5		
CH2027-3ABR		8 un	◇	51669 8		
CH2027-3BLR		8 un	◇	51334 5		
CH2027-3WR		8 un	◇	51189 1		

5/8" RADIUS BUTT HINGE

Full mortise, loose pin, swaged



Individually packed

3" x 3"

CH2028-3ORB-P	Oil Rubbed Bronze (C10B)	12 un	96 un	◇	51110 5	
CH2028-3SAC-P	Satin Antique Copper (C12A)	12 un	96 un	◇	51111 2	
CH2028-3AN-P	Antique Nickel (C17A)	12 un	96 un	◇	51109 9	
CH2028-3C3-P	Bright Brass (C3)	12 un	96 un	◇	51114 3	
CH2028-3SN-P	Satin Nickel (C15)	12 un	96 un	◇	51113 6	
CH2028-3SC-P	Satin Chrome (C26D)	12 un	96 un	◇	51112 9	
CH2028-3AB-P	Antique Brass (C5)	12 un	96 un	◇	51108 2	
CH2028-3BL-P	Mat Black (C19)	12 un	96 un	◇	51513 4	

Individually packed

CH2028-3ORBR		8 un	◇	51686 5		
CH2028-3SACR		8 un	◇	51687 2		
CH2028-3ANR		8 un	◇	51683 4		
CH2028-3C3R		8 un	◇	51685 8		
CH2028-3SNR		8 un	◇	51689 6		
CH2028-3SCR		8 un	◇	51688 9		
CH2028-3ABR		8 un	◇	51682 7		
CH2028-3BLR		8 un	◇	51684 1		

1/4" RADIUS BUTT HINGE

Full mortise, loose pin, swaged

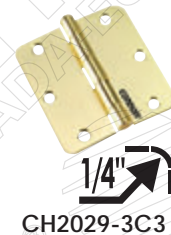

Individually packed

3" x 3"

CH2029-3ORB-P	Oil Rubbed Bronze (C10B)	12 un	96 un	◇	51117 4	
CH2029-3SAC-P	Satin Antique Copper (C12A)	12 un	96 un	◇	51115 0	
CH2029-3AN-P	Antique Nickel (C17A)	12 un	96 un	◇	51116 7	
CH2029-3C3-P	Bright Brass (C3)	12 un	96 un	◇	51118 1	
CH2029-3SN-P	Satin Nickel (C15)	12 un	96 un	◇	51119 8	
CH2029-3SC-P	Satin Chrome (C26D)	12 un	96 un	◇	51120 4	
CH2029-3AB-P	Antique Brass (C5)	12 un	96 un	◇	51121 1	
CH2029-3BL-P	Mat Black (C19)	12 un	96 un	◇	51743 5	

Individually packed

CH2029-3ORBR		8 un	◇	51700 8		
CH2029-3SACR		8 un	◇	51701 5		
CH2029-3ANR		8 un	◇	51698 8		
CH2029-3C3R		8 un	◇	51699 5		
CH2029-3SNR		8 un	◇	51703 9		
CH2029-3SCR		8 un	◇	51702 2		
CH2029-3ABR		8 un	◇	51697 1		
CH2029-3BLR		8 un	◇	51800 5		

50-08

Technical specifications are subject to change without prior notice
 condor is a registered trademark of Canada-Europe Ltd.
 Representation or reproduction of this document in any form or by any means is strictly prohibited.



HINGES



F: 1.855.329.8181 T: 1.800.363.9994

◇ breakable pack

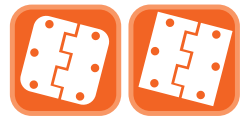

POLY BAGGED



CARDED

Oil Rubbed Bronze

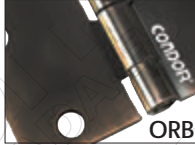

ORB
C10B

Satin Antique Copper



SAC
C12A

Antique Nickel



AN
C17A

Bright Brass

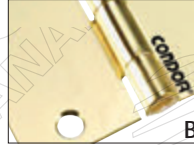

B
C3

Satin Nickel



SN
C15

Zinc

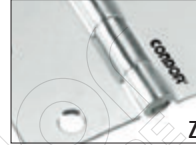

Z
C2G

Satin Stainless Steel



SS
C32D

Antique Brass



AB
C5

Mat Black



BL
C19

White



W

Satin Chrome



SC
C26D

Plain Steel



PS

SQUARE BUTT HINGE

Full mortise, loose pin, swaged

Individually packed

3-1/2" x 3-1/2"

Individually packed



F



7 74470...



7 74470...

CH2027-35ORB-P	Oil Rubbed Bronze (C10B)	12 un	96 un	◇	51089 4
CH2027-35SAC-P	Satin Antique Copper (C12A)	12 un	96 un	◇	51090 0
CH2027-35AN-P	Antique Nickel (C17A)	12 un	96 un	◇	51088 7
CH2027-35C3-P	Bright Brass (C3)	12 un	96 un	◇	51093 1
CH2027-35SN-P	Satin Nickel (C15)	12 un	96 un	◇	51091 7
CH2027-35SC-P	Satin Chrome (C26D)	12 un	96 un	◇	51092 4
CH2027-35AB-P	Antique Brass (C5)	12 un	96 un	◇	51087 0
CH2027-35BL-P	Mat Black (C19)	12 un	96 un	◇	51564 6
CH2027-35W-P	White	12 un	96 un	◇	51913 2

CH2027-35ORBR	8 un	◇	51665 0
CH2027-35SACR	8 un	◇	51666 7
CH2027-35ANR	8 un	◇	51663 6
CH2027-35C3R	8 un	◇	51664 3
CH2027-35SNR	8 un	◇	51668 1
CH2027-35SCR	8 un	◇	51667 4
CH2027-35ABR	8 un	◇	51662 9
CH2027-35BLR	8 un	◇	51333 8
CH2027-35WR	8 un	◇	51190 7



CH2027-35SN

5/8" RADIUS BUTT HINGE

Full mortise, loose pin, swaged

Individually packed

3-1/2" x 3-1/2"

Individually packed



F



7 74470...



7 74470...

CH2028-35ORB-P	Oil Rubbed Bronze (C10B)	12 un	96 un	◇	51103 7
CH2028-35SAC-P	Satin Antique Copper (C12A)	12 un	96 un	◇	51104 4
CH2028-35AN-P	Antique Nickel (C17A)	12 un	96 un	◇	51102 0
CH2028-35C3-P	Bright Brass (C3)	12 un	96 un	◇	51107 5
CH2028-35SN-P	Satin Nickel (C15)	12 un	96 un	◇	51106 8
CH2028-35SC-P	Satin Chrome (C26D)	12 un	96 un	◇	51105 1
CH2028-35AB-P	Antique Brass (C5)	12 un	96 un	◇	51101 3
CH2028-35BL-P	Mat Black (C19)	12 un	96 un	◇	51514 1

CH2028-35ORBR	8 un	◇	51678 0
CH2028-35SACR	8 un	◇	51679 7
CH2028-35ANR	8 un	◇	51676 6
CH2028-35C3R	8 un	◇	51677 3
CH2028-35SNR	8 un	◇	51681 0
CH2028-35SCR	8 un	◇	51680 3
CH2028-35ABR	8 un	◇	51675 9
CH2028-35BLR	8 un	◇	51835 7



5/8"

CH2028-35SC

1/4" RADIUS BUTT HINGE

Full mortise, loose pin, swaged

Individually packed

3-1/2" x 3-1/2"

Individually packed



F



7 74470...



7 74470...

CH2029-35ORB-P	Oil Rubbed Bronze (C10B)	12 un	96 un	◇	51124 2
CH2029-35SAC-P	Satin Antique Copper (C12A)	12 un	96 un	◇	51122 8
CH2029-35AN-P	Antique Nickel (C17A)	12 un	96 un	◇	51123 5
CH2029-35C3-P	Bright Brass (C3)	12 un	96 un	◇	51125 9
CH2029-35SN-P	Satin Nickel (C15)	12 un	96 un	◇	51126 6
CH2029-35SC-P	Satin Chrome (C26D)	12 un	96 un	◇	51127 3
CH2029-35AB-P	Antique Brass (C5)	12 un	96 un	◇	51128 0
CH2029-35BL-P	Mat Black (C19)	12 un	96 un	◇	51744 2

CH2029-35ORBR	8 un	◇	51693 3
CH2029-35SACR	8 un	◇	51694 0
CH2029-35ANR	8 un	◇	51691 9
CH2029-35C3R	8 un	◇	51692 6
CH2029-35SNR	8 un	◇	51696 4
CH2029-35SCR	8 un	◇	51695 7
CH2029-35ABR	8 un	◇	51690 2
CH2029-35BLR	8 un	◇	51839 5



1/4"

CH2029-35AB



F: 1.855.329.8181 T: 1.800.363.9994

◇ breakable pack

HINGES



7 74470 1XXXXX 1X



BOXED BY PAIR



CARDED BY PAIR



CARDED BY UNIT



STAINLESS STEEL

SQUARE BUTT HINGES

Full mortise, loose pin, swaged

Packed by pair



F



7 74470...

CH2027-4C3	Bright Brass (C3)	4"	4"	40 pr ◇	50197 7
● CH2027N-4W	White	4"	4"	40 pr ◇	51352 9
● CH2027N-4BL	Mat Black (C19)	4"	4"	40 pr ◇	51355 0
●	Non-removable pin				

Packed by pair



7 74470...

---	---	---	---	---	---
● CH2027N-4WR		5 pr ◇			51335 2
● CH2027N-4BLR		5 pr ◇			51336 9
●	Non-removable pin				

STAINLESS STEEL SQUARE BUTT HINGE

Satin stainless steel finish

Full mortise, button tip

3 to 3-1/2 in. = 3 holes, 4 in. = 4 holes

TYPE 304

Packed by pair



7 74470...

CH2027-3SS		3"	3"	0.077"	40 pr ◇	51347 5
CH2027-35SS		3-1/2"	3-1/2"	0.088"	40 pr ◇	51348 2
● CH2027N-4SS		4"	4"	0.096"	30 pr ◇	51349 9
●	Non-removable pin					

Packed by pair



7 74470...

CH2027-3SSR		8 pr ◇				51171 6
CH2027-35SSR		8 pr ◇				51172 3
● CH2027N-4SSR		5 pr ◇				51173 0
●	Non-removable pin					

SQUARE BUTT HINGE

Full mortise, loose pin, swaged

ZINC PLATED
Individually packed

ZINC PLATED
Packed by pair

PLAIN STEEL
Packed by pair



7 74470...



7 74470...



7 74470...

1805ZU-2	2"	2"	40 un ◇	50940 9
1805ZU-25	2-1/2"	2-1/2"	20 un ◇	50941 6
1805ZU-3	3"	3"	20 un ◇	50942 3
1805ZU-35	3-1/2"	3-1/2"	20 un ◇	50943 0
1805ZU-4	4"	4"	20 un ◇	50944 7

C1805Z-2	200 pr ◇	50949 2
C1805Z-25	60 pr ◇	50486 2
C1805Z-3	50 pr ◇	50487 9
C1805Z-35	50 pr ◇	50488 6
C1805Z-4	40 pr ◇	50489 3

---	---	---
C1805-25	60 pr ◇	50470 1
C1805-3	50 pr ◇	50471 8
C1805-35	50 pr ◇	50472 5
C1805-4	40 pr ◇	50363 6



HINGES

F: 1.855.329.8181 T: 1.800.363.9994
 ◇ breakable pack



BOXED BY PAIR 3 UNITS PER BOX CARDED BY UNIT

ADJUSTABLE SPRING TEMPLATE HINGES



C4027-35SN



C4029-35SN



C4029-4SN



SQUARE CORNERS

Packed by pair

SQUARE CORNERS Individually packed

PR	F	UN	UN	PR	UN	UN	PR	UN	UN
C4027-35C3	Bright Brass (C3)	3-1/2"	3-1/2"	6 pr ◇	20 ◇	51730 5	C4027-35C3R	5 un ◇	51184 6
C4027-35SN	Satin Nickel (C15)	3-1/2"	3-1/2"	6 pr ◇	20 ◇	51732 9	C4027-35SNR	5 un ◇	51186 0
C4027-35SC	Satin Chrome (C26D)	3-1/2"	3-1/2"	6 pr ◇	20 ◇	51731 2	C4027-35SCR	5 un ◇	51185 3

1/4" RADIUS CORNER

Packed by pair

1/4" RADIUS CORNER Individually packed

PR	F	UN	UN	PR	UN	UN	PR	UN	UN
C4029-35C3	Bright Brass (C3)	3-1/2"	3-1/2"	6 pr ◇	20 ◇	51733 6	C4029-35C3R	5 un ◇	51261 4
C4029-4C3	Bright Brass (C3)	4"	4"	6 pr ◇	20 ◇	51736 7	C4029-4C3R	5 un ◇	51262 1
C4029-35SC	Satin Chrome (C26D)	3-1/2"	3-1/2"	6 pr ◇	20 ◇	51734 3	C4029-35SCR	5 un ◇	51263 8
C4029-4SC	Satin Chrome (C26D)	4"	4"	6 pr ◇	20 ◇	51737 4	C4029-4SCR	5 un ◇	51266 9
C4029-35SN	Satin Nickel (C15)	3-1/2"	3-1/2"	6 pr ◇	20 ◇	51735 0	C4029-35SNR	5 un ◇	51264 5
C4029-4SN	Satin Nickel (C15)	4"	4"	6 pr ◇	20 ◇	51738 1	C4029-4SNR	5 un ◇	51265 2

ADJUSTABLE SPRING LOADED TEMPLATE HINGE

UL and ULC listed for fire door applications, easily adjusted spring tension. Screw holes conform to "ANSI" specifications. With adjusting rod, wood and machine screws included



PR	F	UN	UN	PR	UN	UN	PR	UN	UN
C4310C435	Satin Brass (C4)	3 -1/2"	3 -1/2"	20 pr ◇	50709 2		C4310C435		
C4310C444	Satin Brass (C4)	4"	4"	20 pr ◇	50710 8		C4310C444		
C4310C4454	Satin Brass (C4)	4-1/2"	4"	20 pr ◇	50711 5		C4310C4454		
C4310C26D35	Satin Chrome (C26D)	3-1/2"	3-1/2"	20 pr ◇	50712 2		C4310C26D35		
C4310C26D44	Satin Chrome (C26D)	4"	4"	20 pr ◇	50713 9		C4310C26D44		
C4310C26D454	Satin Chrome (C26D)	4-1/2"	4"	20 pr ◇	50714 6		C4310C26D454		



C4310C435

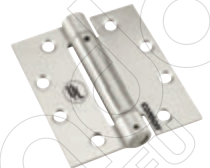

C4310C26D44

SQUARE BUTT BALL BEARING HINGE

Slimline design bearing for wood doors
 3 to 3-1/2 in. = 3 holes, 4 to 4-1/2 in. = 4 holes

Packed by pair

STEEL, BRIGHT BRASS PLATED (C3)

STEEL, SATIN NICKEL PLATED (C15)

PR	UN	UN	PR	UN	UN	PR	UN	UN	PR	UN	UN
CB848SDB33	3"	3"	50 pr ◇	50299 8		CB848C1533	3"	3"	50 pr ◇	50669 9	
CB848SDB35	3-1/2"	3-1/2"	30 pr ◇	50190 8		CB848C1535	3-1/2"	3-1/2"	30 pr ◇	50670 5	
CB848SDB44	4"	4"	30 pr ◇	50191 5		CB848C1544	4"	4"	30 pr ◇	50671 2	
CB848SDB45	4-1/2"	4-1/2"	30 pr ◇	50192 2		CB848C1545	4-1/2"	4-1/2"	30 pr ◇	50672 9	

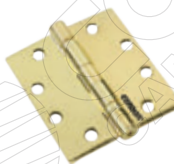

CB848SDB44



CB848C1544

BUTT BALL BEARING HINGE

Wrought steel, full mortise template type, removable pin, regular weight
 #12-24 x 1 1/2 in. x 24 machine screws & #12 x 1-1/4 in. x 24 wood screws

STEEL, SATIN NICKEL PLATED (C15)

UN	UN	UN	PR	UN	UN	UN
C179C15454	4-1/2"	4"	3 un	20 ◇ (x3)	50253 0	

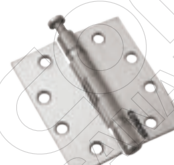

C179C15454

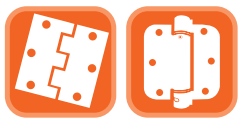

F: 1.855.329.8181 T: 1.800.363.9994

◇ breakable pack

HINGES



ZINC (C2G) PLATED

LIGHT T-HINGE

Packed per unit

753L2			2"	3/4"	2-1/16"	0.052"	20 un	800 ◇	51754 1
753L3			3"	13/16"	2-7/32"	0.056"	20 un	400 ◇	51755 8
753L4			4"	15/16"	2-7/16"	0.056"	20 un	400 ◇	51756 5
753L5			5"	31/32"	2-1/2"	0.061"	20 un	400 ◇	51757 2
753L6			6"	1-1/16"	3-1/8"	0.072"	20 un	400 ◇	51758 9

ZINC (C2G) PLATED

LIGHT STRAP HINGE

Packed per unit

752L2			2"	1-1/8"	0.052"	20 un	800 ◇	51749 7
752L3			3"	1-1/16"	0.056"	20 un	600 ◇	51750 3
752L4			4"	1-3/16"	0.056"	20 un	400 ◇	51751 0
752L5			5"	1-5/16"	0.061"	20 un	300 ◇	51752 7
752L6			6"	1-1/2"	0.072"	20 un	240 ◇	51753 4

ZINC (C2G) PLATED

BACK FLAP HINGE

Fixed pin

C400-1		1"	2-7/8"	25 pr ◇	50666 8	C400-1R	10 pr ◇	51764 0
C400-125		1-1/4"	3-1/4"	10 pr ◇	50610 1	C400-125R	12 pr ◇	51765 7
C400-15		1-1/2"	3-1/4"	10 pr ◇	50611 8	C400-15R	12 pr ◇	51766 4
C400-2		2"	4-1/8"	10 pr ◇	50665 1	C400-2R	12 pr ◇	51767 1

BRIGHT BRASS PLATED (C3)

ORNAMENTAL CABINET HINGE

Fixed pin

C401B075		1-3/8"	3/4"	2-1/4"	5 pr ◇	51205 8	C401B075R	10 pr ◇	51377 2
C401B1		1-7/8"	1"	3-1/8"	5 pr ◇	51206 5	C401B1R	12 pr ◇	51378 9

BRIGHT BRASS (C3) PLATED

3-LEAF HINGE

Fixed pin, swaged

C130B		3-1/2"	2-1/2"	20 pr ◇	50356 8	C130BR	8 pr ◇	51768 8

BRIGHT BRASS (C3) PLATED

CAFE DOOR HINGE

Nylon bearings. Each set is for two doors

C3000		1 pr	10 pr ◇	50691 0	C3000R	1 pr	5 pr ◇	51763 3

DOUBLE ACTING HINGE

BLACK

C2090-3BL		3"	20 pr ◇	50159 5
C2090-4BL		4"	20 pr ◇	50160 1
C2090-5BL		5"	20 pr ◇	50272 1
C2090-6BL		6"	20 pr ◇	50161 8

753L2

753L6

752L2

752L6

C400-1

C401B075

C130B

C3000

C2090-3BL

HINGES

F: 1.855.329.8181 T: 1.800.363.9994

◇ breakable pack

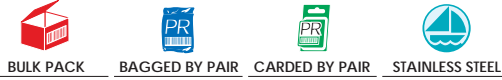

FIXED PIN NARROW BUTT HINGE

Fixed pin, swaged
1 to 2 in. = 2 holes, 2-1/2 & 3 in. = 3 holes

ZINC PLATED (C2G)

1"	1"	6021Z-1	12 pr	50481 7	6021Z-1-P	10 pr	50494 7	6021Z-1R	10 pr	51801 2
1-1/2"	1-1/4"	6021Z-15	12 pr	50482 4	6021Z-15-P	10 pr	50495 4	6021Z-15R	10 pr	51802 9
2"	1-1/2"	6021Z-2	12 pr	50483 1	6021Z-2-P	10 pr	50496 1	6021Z-2R	12 pr	51803 6
2-1/2"	1-5/8"	6021Z-25	12 pr	50484 8	6021Z-25-P	10 pr	50497 8	6021Z-25R	12 pr	51804 3
3"	2"	6021Z-3	12 pr	50485 5	6021Z-3-P	10 pr	50498 5	6021Z-3R	8 pr	51805 0



6021Z-2

BRIGHT BRASS PLATED (C3)

1"	1"	6021B-1	12 pr	50425 1	6021B-1-P	10 pr	50153 3	6021B-1R	10 pr	51806 7
1-1/2"	1-1/4"	6021B-15	12 pr	50426 8	6021B-15-P	10 pr	50154 0	6021B-15R	10 pr	51807 4
2"	1-1/2"	6021B-2	12 pr	50427 5	6021B-2-P	10 pr	50155 7	6021B-2R	12 pr	51808 1
2-1/2"	1-5/8"	6021B-25	12 pr	50428 2	6021B-25-P	10 pr	50156 4	6021B-25R	12 pr	51809 8
3"	2"	6021B-3	12 pr	50429 9	6021B-3-P	10 pr	50157 1	6021B-3R	8 pr	51810 4



6021B-3

REMOVABLE PIN NARROW BUTT HINGE

Removable pin, swaged
1 to 2 in. = 2 holes, 2-1/2 & 3 in. = 3 holes

ZINC PLATED (C2G)

1"	1"	6021RZ-1	12 pr	51267 6	6021RZ-1-P	10 pr	51343 7	6021RZ-1R	10 pr	51811 1
1-1/2"	1-1/4"	6021RZ-15	12 pr	51268 3	6021RZ-15-P	10 pr	51342 0	6021RZ-15R	10 pr	51812 8
2"	1-1/2"	6021RZ-2	12 pr	51269 0	6021RZ-2-P	10 pr	51345 1	6021RZ-2R	12 pr	51813 5
2-1/2"	1-5/8"	6021RZ-25	12 pr	51270 6	6021RZ-25-P	10 pr	51344 4	6021RZ-25R	12 pr	51814 2
3"	2"	6021RZ-3	12 pr	51271 3	6021RZ-3-P	10 pr	51346 8	6021RZ-3R	8 pr	51815 9



6021RZ-2

BRIGHT BRASS PLATED (C3)

1"	1"	6021RB-1	12 pr	51272 0	6021RB-1-P	10 pr	51337 6	6021RB-1R	10 pr	51816 6
1-1/2"	1-1/4"	6021RB-15	12 pr	51273 7	6021RB-15-P	10 pr	51338 3	6021RB-15R	10 pr	51817 3
2"	1-1/2"	6021RB-2	12 pr	51274 4	6021RB-2-P	10 pr	51340 6	6021RB-2R	12 pr	51818 0
2-1/2"	1-5/8"	6021RB-25	12 pr	51275 1	6021RB-25-P	10 pr	51339 0	6021RB-25R	12 pr	51819 7
3"	2"	6021RB-3	12 pr	51276 8	6021RB-3-P	10 pr	51341 3	6021RB-3R	8 pr	51820 3



6021RB-3

STAINLESS STEEL REMOVABLE PIN NARROW BUTT HINGE

Removable pin, swaged
2 in. = 2 holes

TYPE 304

2"	1-1/2"	6021RSS-2	10 pr ◇	51746 6	6021RSS-2-P	10 pr ◇	51357 4	6021RSS-2R	12 pr ◇	51762 6
----	--------	-----------	---------	---------	-------------	---------	---------	------------	---------	---------



6021RSS-2



F: 1.855.329.8181 T: 1.800.363.9994



FINISHING HARDWARE

◇ breakable pack



HEAVY DUTY HAT & COAT HOOK

Individually packed

C6280



Code	Finish	Material	Length	Width	Weight	Pack Size	Weight	Weight	Weight	Weight
C6280ORB	Oil Rubbed Bronze (C10B)	5-1/2"	3-1/4"	10 ◇	200 ◇	50998 0	C6280ORBR	5 ◇	51572 1	
C6280SAC	Satin Antique Copper (C12A)	5-1/2"	3-1/4"	10 ◇	200 ◇	50999 7	C6280SACR	5 ◇	51574 5	
C6280AN	Antique Nickel (C17A)	5-1/2"	3-1/4"	10 ◇	200 ◇	50996 6	C6280ANR	5 ◇	51575 2	
C6280B	Bright Brass (C3)	5-1/2"	3-1/4"	10 ◇	200 ◇	50562 3	C6280BR	5 ◇	51576 9	
C6280SN	Satin Nickel (C15)	5-1/2"	3-1/4"	10 ◇	200 ◇	51001 6	C6280SNR	5 ◇	51577 6	
C6280SC	Satin Chrome (C26D)	5-1/2"	3-1/4"	10 ◇	200 ◇	51000 9	C6280SCR	5 ◇	51578 3	
C6280AB	Antique Brass (C5)	5-1/2"	3-1/4"	10 ◇	200 ◇	50995 9	C6280ABR	5 ◇	51579 0	
C6280CH	Chrome (C26)	5-1/2"	3-1/4"	10 ◇	200 ◇	50563 0	C6280CHR	5 ◇	51580 6	
C6280W	White Enamelled	5-1/2"	3-1/4"	10 ◇	200 ◇	51210 2	C6280WR	5 ◇	51581 3	
C6280BL	Mat Black (C19)	5-1/2"	3-1/4"	10 ◇	200 ◇	51556 1	C6280BLR	5 ◇	51582 0	

C690

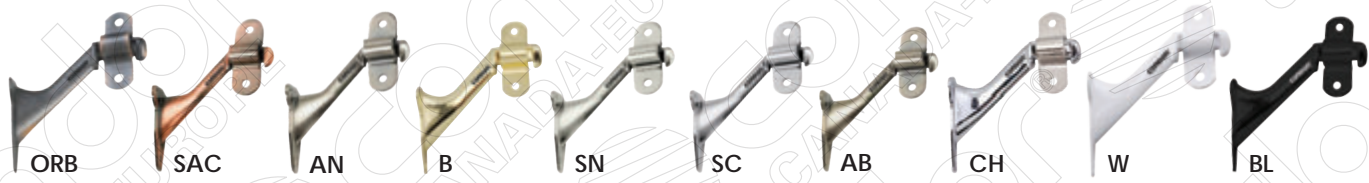

HANDRAIL BRACKET

Individually packed

Code	Finish	Material	Length	Weight	Pack Size	Weight	Weight	Weight	Weight
C690ORB	Oil Rubbed Bronze (C10B)	2-1/2"	20 ◇	200 ◇	51005 4	C690ORBR	5 ◇	51628 5	
C690SAC	Satin Antique Copper (C12A)	2-1/2"	20 ◇	200 ◇	51006 1	C690SACR	5 ◇	51627 8	
C690AN	Antique Nickel (C17A)	2-1/2"	20 ◇	200 ◇	51003 0	C690ANR	5 ◇	51632 2	
C690B	Bright Brass (C3)	2-1/2"	20 ◇	200 ◇	50059 8	C690BR	5 ◇	51630 8	
C690SN	Satin Nickel (C15)	2-1/2"	20 ◇	200 ◇	51008 5	C690SNR	5 ◇	51625 4	
C690SC	Satin Chrome (C26D)	2-1/2"	20 ◇	200 ◇	51007 8	C690SCR	5 ◇	51626 1	
C690AB	Antique Brass (C5)	2-1/2"	20 ◇	200 ◇	50519 7	C690ABR	5 ◇	51633 9	
C690CH	Chrome (C26) (C26)	2-1/2"	20 ◇	200 ◇	51748 0	C690CHR	5 ◇	51629 2	
C690W	White Enamelled	2-1/2"	20 ◇	200 ◇	50845 7	C690WR	5 ◇	51624 7	
C690BL	Mat Black (C19)	2-1/2"	20 ◇	200 ◇	51568 4	C690BLR	5 ◇	51631 5	



HEAVY DUTY HANDRAIL BRACKET

Individually packed

C695B	Bright Brass (C3)	2-3/4"	20 ◇	50847 1	C695BR	4 ◇	51583 7
-------	-------------------	--------	------	---------	--------	-----	---------



HAT & COAT HOOK

Individually packed

C6211



	F						
C6211ORB	Oil Rubbed Bronze (C10B)	3-1/2"	2-1/4"	10 ◇	300 ◇	50984 3	C6211ORBR 8 ◇ 51769 5
C6211SAC	Satin Antique Copper (C12A)	3-1/2"	2-1/4"	10 ◇	300 ◇	50985 0	C6211SACR 8 ◇ 51770 1
C6211AN	Antique Nickel (C17A)	3-1/2"	2-1/4"	10 ◇	300 ◇	50982 9	C6211ANR 8 ◇ 51771 8
C6211B	Bright Brass (C3)	3-1/2"	2-1/4"	10 ◇	300 ◇	50560 9	C6211BR 8 ◇ 51772 5
C6211SN	Satin Nickel (C15)	3-1/2"	2-1/4"	10 ◇	300 ◇	50987 4	C6211SNR 8 ◇ 51773 2
C6211SC	Satin Chrome (C26D)	3-1/2"	2-1/4"	10 ◇	300 ◇	50986 7	C6211SCR 8 ◇ 51774 9
C6211AB	Antique Brass (C5)	3-1/2"	2-1/4"	10 ◇	300 ◇	50981 2	C6211ABR 8 ◇ 51775 6
C6211CH	Chrome (C26)	3-1/2"	2-1/4"	10 ◇	300 ◇	50561 6	C6211CHR 8 ◇ 51776 3
C6211W	White Enamelled	3-1/2"	2-1/4"	10 ◇	300 ◇	51207 2	C6211WR 8 ◇ 51777 0
C6211BL	Mat Black (C19)	3-1/2"	2-1/4"	10 ◇	300 ◇	51555 4	C6211BLR 8 ◇ 51778 7

SINGLE WARDROBE HOOK

Individually packed

C6212



	F						
C6212ORB	Oil Rubbed Bronze (C10B)	1"	1-1/4"	20 ◇	400 ◇	50991 1	C6212ORBR 12 ◇ 51648 3
C6212SAC	Satin Antique Copper (C12A)	1"	1-1/4"	20 ◇	400 ◇	50992 8	C6212SACR 12 ◇ 51647 6
C6212AN	Antique Nickel (C17A)	1"	1-1/4"	20 ◇	400 ◇	50989 8	C6212ANR 12 ◇ 51652 0
C6212B	Bright Brass (C3)	1"	1-1/4"	20 ◇	400 ◇	50564 7	C6212BR 12 ◇ 51650 6
C6212SN	Satin Nickel (C15)	1"	1-1/4"	20 ◇	400 ◇	50994 2	C6212SNR 12 ◇ 51645 2
C6212SC	Satin Chrome (C26D)	1"	1-1/4"	20 ◇	400 ◇	50993 5	C6212SCR 12 ◇ 51646 9
C6212AB	Antique Brass (C5)	1"	1-1/4"	20 ◇	400 ◇	50988 1	C6212ABR 12 ◇ 51653 7
C6212CH	Chrome (C26)	1"	1-1/4"	20 ◇	400 ◇	50565 4	C6212CHR 12 ◇ 51649 0
C6212W	White Enamelled	1"	1-1/4"	20 ◇	400 ◇	51208 9	C6212WR 12 ◇ 51644 5
C6212BL	Mat Black (C19)	1"	1-1/4"	20 ◇	400 ◇	51569 1	C6212BLR 12 ◇ 51651 3

DOUBLE WARDROBE HOOK

Individually packed

C6213



	F						
C6213ORB	Oil Rubbed Bronze (C10B)	1-1/2"	1"	10 ◇	240 ◇	51134 1	C6213ORBR 8 ◇ 51638 4
C6213SAC	Satin Antique Copper (C12A)	1-1/2"	1"	10 ◇	240 ◇	51132 7	C6213SACR 8 ◇ 51637 7
C6213AN	Antique Nickel (C17A)	1-1/2"	1"	10 ◇	240 ◇	51133 4	C6213ANR 8 ◇ 51642 1
C6213B	Bright Brass (C3)	1-1/2"	1"	10 ◇	240 ◇	50566 1	C6213BR 8 ◇ 51640 7
C6213SN	Satin Nickel (C15)	1-1/2"	1"	10 ◇	240 ◇	51136 5	C6213SNR 8 ◇ 51635 3
C6213SC	Satin Chrome (C26D)	1-1/2"	1"	10 ◇	240 ◇	51137 2	C6213SCR 8 ◇ 51636 0
C6213AB	Antique Brass (C5)	1-1/2"	1"	10 ◇	240 ◇	51138 9	C6213ABR 8 ◇ 51643 8
C6213CH	Chrome (C26)	1-1/2"	1"	10 ◇	240 ◇	50567 8	C6213CHR 8 ◇ 51639 1
C6213W	White Enamelled	1-1/2"	1"	10 ◇	240 ◇	51209 6	C6213WR 8 ◇ 51634 6
C6213BL	Mat Black (C19)	1-1/2"	1"	10 ◇	240 ◇	51528 8	C6213BLR 8 ◇ 51641 4



F: 1.855.329.8181 T: 1.800.363.9994

◇ breakable pack



FINISHING HARDWARE



C16

DOOR HOLDER

Individually packed



Part No.	Finish	Description	Length	Weight	Quantity	Barcode	Part No.	Weight	Quantity	Barcode
C16ORB	Oil Rubbed Bronze (C10B)	5"	6 ◇	120 ◇	50977 5	C16ORBR	5 ◇	51585 1	7 74470...	
C16SAC	Satin Antique Copper (C12A)	5"	6 ◇	120 ◇	50978 2	C16SACR	5 ◇	51586 8	7 74470...	
C16AN	Antique Nickel (C17A)	5"	6 ◇	120 ◇	50975 1	C16ANR	5 ◇	51587 2	7 74470...	
C16B	Bright Brass (C3)	5"	6 ◇	120 ◇	50976 8	C16BR	5 ◇	51588 2	7 74470...	
C16SN	Satin Nickel (C15)	5"	6 ◇	120 ◇	50980 5	C16SNR	5 ◇	51589 9	7 74470...	
C16SC	Satin Chrome (C26D)	5"	6 ◇	120 ◇	50979 9	C16SCR	5 ◇	51590 5	7 74470...	
C16AB	Antique Brass (C5)	5"	6 ◇	120 ◇	50974 4	C16ABR	5 ◇	51591 2	7 74470...	
C16BL	Mat Black (C19)	5"	6 ◇	120 ◇	51541 7	C16BLR	5 ◇	51592 9	7 74470...	



ZINC DIE CAST

DOOR HOLDER

Individually packed

Part No.	Finish	Length	Weight	Quantity	Barcode
C17SC	Satin Chrome (C26D)	5"	10 ◇	100 ◇	51467 0
C17B	Bright Brass (C3)	5"	10 ◇	100 ◇	50599 9



C17REP

REPLACEMENT RUBBER TIP

Replacement rubber tip for C17 series door holders

Part No.	Color	Length	Weight	Quantity	Barcode
C17REP	Grey	1-1/8"	10	800 ◇	50677 4

C806

HEAVY DUTY HINGE-PIN DOOR STOP

With rubber bumpers
Individually packed



Part No.	Finish	Length	Width	Weight	Quantity	Barcode	Part No.	Weight	Quantity	Barcode
C806ORB	Oil Rubbed Bronze (C10B)	2"	1-1/8"	20 ◇	400 ◇	51012 2	C806ORBR	12 ◇	51780 0	7 74470...
C806SAC	Satin Antique Copper (C12A)	2"	1-1/8"	20 ◇	400 ◇	51013 9	C806SACR	12 ◇	51781 7	7 74470...
C806AN	Antique Nickel (C17A)	2"	1-1/8"	20 ◇	400 ◇	51010 8	C806ANR	12 ◇	51782 4	7 74470...
C806B	Bright Brass (C3)	2"	1-1/8"	20 ◇	400 ◇	51011 5	C806BR	12 ◇	51783 1	7 74470...
C806SN	Satin Nickel (C15)	2"	1-1/8"	20 ◇	400 ◇	51015 3	C806SNR	12 ◇	51784 8	7 74470...
C806SC	Satin Chrome (C26D)	2"	1-1/8"	20 ◇	400 ◇	51014 6	C806SCR	12 ◇	51785 5	7 74470...
C806AB	Antique Brass (C5)	2"	1-1/8"	20 ◇	400 ◇	51009 2	C806ABR	12 ◇	51786 2	7 74470...
C806CH	Chrome (C26)	2"	1-1/8"	20 ◇	400 ◇	51158 7	C806CHR	12 ◇	51787 9	7 74470...
C806W	White Enamelled	2"	1-1/8"	20 ◇	400 ◇	51191 4	C806WR	12 ◇	51788 6	7 74470...
C806BL	Mat Black (C19)	2"	1-1/8"	20 ◇	400 ◇	51566 0	C806BLR	12 ◇	51789 3	7 74470...

HINGE-PIN DOOR STOP

With rubber bumpers
Individually packed



C804B

Part No.	Finish	Length	Width	Weight	Quantity	Barcode
C804B	Bright Brass (C3)	1-5/8"	1"	25 ◇	51080 1	7 74470...



6034B

ADJUSTABLE ROLLER CATCH

Die cast construction, adjustable roller tension

Part No.	Finish	Quantity	Barcode
6034B	Bright Brass (C3)	10 ◇	50600 2

FINISHING HARDWARE



F: 1.855.329.8181 T: 1.800.363.9994

◇ breakable pack



74470XXXXXX

FLAGGED



74470XXXXXX

CARDED

FLEXIBLE DOOR STOP

Quality spring, superior finish
Individually packed with Phillips head screw

MA1602



		F		7 74470...		7 74470...	
MA1602ORB		Oil Rubbed Bronze (C10B)	3"	25	500 ◇	51063 4	MA1602ORBR
MA1602SAC		Satin Antique Copper (C12A)	3"	25	500 ◇	51064 1	MA1602SACR
MA1602AN		Antique Nickel (C17A)	3"	25	500 ◇	51059 7	MA1602ANR
MA1602B		Bright Brass (C3)	3"	25	500 ◇	50438 1	MA1602BR
MA1602SN		Satin Nickel (C15)	3"	25	500 ◇	51129 7	MA1602SNR
MA1602SC		Satin Chrome (C26D)	3"	25	500 ◇	51130 3	MA1602SCR
MA1602AB		Antique Brass (C5)	3"	25	500 ◇	50837 2	MA1602ABR
MA1602N		Nickel	3"	25	500 ◇	50440 4	MA1602NR
MA1602W		White Enamelled	3"	25	500 ◇	50846 4	MA1602WR
MA1602BL		Mat Black (C19)	3"	25	500 ◇	51542 4	MA1602BLR

RIGID DOOR STOP

Zinc die cast, superior finish, with integrated screw
Individually packed

MA1603



		F		7 74470...		7 74470...	
MA1603ORB		Oil Rubbed Bronze (C10B)	3"	20 ◇	400 ◇	51068 9	MA1603ORBR
MA1603SAC		Satin Antique Copper (C12A)	3"	20 ◇	400 ◇	51069 6	MA1603SACR
MA1603AN		Antique Nickel (C17A)	3"	20 ◇	400 ◇	51066 5	MA1603ANR
MA1603B		Bright Brass (C3)	3"	20 ◇	400 ◇	51067 2	MA1603BR
MA1603SN		Satin Nickel (C15)	3"	20 ◇	400 ◇	51071 9	MA1603SNR
MA1603SC		Satin Chrome (C26D)	3"	20 ◇	400 ◇	51070 2	MA1603SCR
MA1603AB		Antique Brass (C5)	3"	20 ◇	400 ◇	51065 8	MA1603ABR
MA1603W		White Enamelled	3"	20 ◇	400 ◇	51196 9	MA1603WR
MA1603BL		Mat Black (C19)	3"	20 ◇	400 ◇	51518 9	MA1603BLR

ADJUSTABLE BALL CATCH

Die cast construction, adjustable ball tension

6035

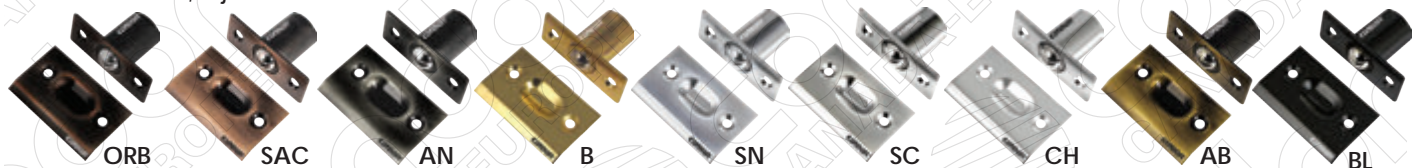

		F		7 74470...		7 74470...	
6035ORB		Oil Rubbed Bronze (C10B)	10 ◇	200 ◇	51720 6	6035ORBR	8 ◇ 51845 6
6035SAC		Satin Antique Copper (C12A)	10 ◇	200 ◇	51557 8	6035SACR	8 ◇ 51846 3
6035AN		Antique Nickel (C17A)	10 ◇	200 ◇	51724 4	6035ANR	8 ◇ 51841 8
6035B		Bright Brass (C3)	10 ◇	200 ◇	51562 2	6035BR	8 ◇ 51843 2
6035SN		Satin Nickel (C15)	10 ◇	200 ◇	51560 8	6035SNR	8 ◇ 51848 7
6035SC		Satin Chrome (C26D)	10 ◇	200 ◇	51558 5	6035SCR	8 ◇ 51847 0
6035CH		Chrome (C26)	10 ◇	200 ◇	51559 2	6035CHR	8 ◇ 51844 9
6035AB		Antique Brass (C5)	10 ◇	200 ◇	51722 0	6035ABR	8 ◇ 51840 1
6035BL		Mat Black (C19)	10 ◇	200 ◇	51719 0	6035BLR	8 ◇ 51842 5



F: 1.855.329.8181 T: 1.800.363.9994

◇ breakable pack

DOOR HARDWARE



FLAGGED



CARDED

MAGNETIC CATCH

Plastic case



CM1450WS

CM1560W



CM1450WS	2"	1"	Beige	25	50212 7
CM1560W	2"	1"	White	25	50661 3

DOUBLE ROLLER CABINET CATCH

Zinc plated



C3631C2G



C3631C2G	20	100	◇	50337 7
----------	----	-----	---	---------

DOUBLE BALL CATCH

SOLID BRASS

Adjustable spring tension



CB175SB



CB175SB	1-3/4"	10		50808 2
CB2SB	2"	10		50809 9

FLOOR DOOR STOPS

Die cast construction, rubber bumper



CT200SC

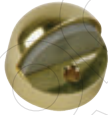

CT218B



	Type							
CT200SC	Satin Chrome (C26D)	Low Profile	1-3/4"	1"	3/32"	20	◇	51451 9
CT200B	Bright Brass (C3)	Low Profile	1-3/4"	1"	3/32"	20	◇	51450 2
CT218SC	Satin Chrome (C26D)	High Profile	1-3/4"	1-1/2"	1/2"	20	◇	51449 6
CT218B	Bright Brass (C3)	High Profile	1-3/4"	1-1/2"	1/2"	20	◇	51448 9

WALL DOOR STOPS

Die cast construction, rubber bumper



CT234W



CT231B



	Type							
CT234W	White plastic (adhesive)	Convex	2-1/4"	1-1/8"	10 pr	◇		51203 4
CT231SC	Satin Chrome (C26D)	Convex	2-1/2"	1"	10 un	◇		51447 2
CT231B	Bright Brass (C3)	Convex	2-1/2"	1"	10 un	◇		51489 2
CT233SC	Satin Chrome (C26D)	Concave	2-1/2"	1"	10 un	◇		51446 5
CT233B	Bright Brass (C3)	Concave	2-1/2"	1"	10 un	◇		51610 0

RUBBER DOOR WEDGE

Brown finish rubber



DW150



DW150	4"	1-1/8"	1 pr	10 pr	50684 2	DW150R	1 pr	5 pr	◇	51823 4
-------	----	--------	------	-------	---------	--------	------	------	---	---------

FLOOR ANGLE DOOR STOP

Brass plated zinc die cast, superior finish, with integrated screw



MA1604B



MA1604B	1-3/8"	1"	20	◇	50441 1	MA1604BR	10	◇	51622 3
---------	--------	----	----	---	---------	----------	----	---	---------

DOOR HOLDERS

Wall mount, floor mount. Zinc die cast, chrome plated



724



725



	Type										
724	Wall	3-1/2"	20	◇	50020 8	725	Floor	2-1/2"	20	◇	50021 5

MAGNETIC DOOR HOLDER

Can be mounted on wall or on the floor. Powerful heavy duty magnet

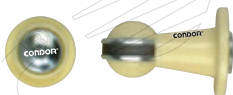

MH401PVC



MH401PVC	Almond White	2-7/8"	12	◇	51911 8	MH401PVCGR	6	◇	50686 6
----------	--------------	--------	----	---	---------	------------	---	---	---------



FLAGGED



CARDED



KEY ALIKE



KEY DIFFERENT

SOLID BRASS PADLOCK

Hardened steel shackle, anti-pick mushroom pins, stainless steel springs
Single locking on # 831 & 832, double locking on # 833 to 836. With two (2) keys

KEY ALIKE

Model	Shackle	Body	Keys	Part No.
C831KA	3/4"	1/2"	12 ◇	51160 0
C832KA	1"	9/16"	12 ◇	51162 4
C833KA	1-1/4"	3/4"	12 ◇	51164 8
C834KA	1-1/2"	7/8"	12 ◇	51166 2
C835KA	1-3/4"	1"	12 ◇	51168 6
C836KA	2"	1-1/8"	6 ◇	51170 9

Key alike #101 to 104 and others available. Please specify when ordering

KEY DIFFERENT

Model	Shackle	Body	Keys	Part No.
C831KD	12 ◇		51159 4	
C832KD	12 ◇		51161 7	
C833KD	12 ◇		51163 1	
C834KD	12 ◇		51165 5	
C835KD	12 ◇		51167 9	
C836KD	6 ◇		51169 3	

KEY DIFFERENT

Model	Shackle	Body	Keys	Part No.
C831KDR	10 ◇		51863 0	
C832KDR	10 ◇		51865 4	
C833KDR	10 ◇		51867 8	
C834KDR	8 ◇		51869 2	
C835KDR	8 ◇		51871 5	
C836KDR	8 ◇		51873 9	



C831KA

SOLID BRASS PADLOCK

Chrome plated hardened steel shackle Single locking on # 261 & 262. Double locking on # 263 to 265
With three (3) Keys. Key blanks available on request

KEY DIFFERENT

Model	Shackle	Body	Keys	Part No.
C261KD	3/4"	13/32"	12 ◇	50696 5
C262KD	1"	15/32"	6 ◇	50697 2
C263KD	1-1/4"	5/8"	6 ◇	50698 9
C264KD	1-1/2"	3/4"	6 ◇	50699 6
C265KD	2"	1"	6 ◇	50800 6



C261KD

SOLID BRASS PADLOCK

With three (3) keys

KEY DIFFERENT

Model	Shackle	Body	Keys	Part No.
PB630B1	1"	19/32"	12 ◇	51888 3
PB630B125	1-1/4"	11/16"	12 ◇	51889 0
PB630B15	1-1/2"	23/32"	6 ◇	51890 6
PB630B2	2"	1-5/32"	6 ◇	51891 3



PB630B1

CAM LOCK

Zinc alloy with stainless steel front, 5/8 in. diameter
Supplied with a straight cam and an angled cam and two (2) keys

KEY DIFFERENT

Model	Shackle	Body	Keys	Part No.
C500-23KD	29/32"		20 ◇	50342 1
C500-30KD	1-3/16"		20 ◇	50343 8

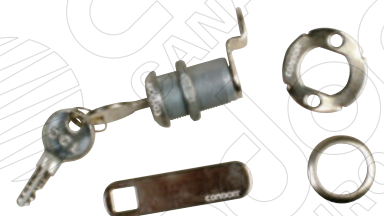

C500-23

LETTER BOX LOCK

Brass plated steel, with two (2) keys

Model	Shackle	Body	Keys	Part No.
LB284BR	10 ◇		50076 5	



LB284BR



F: 1.855.329.8181 T: 1.800.363.9994

◇ breakable pack

SECURITY



SECURITY LATCH

Individually packed

C813

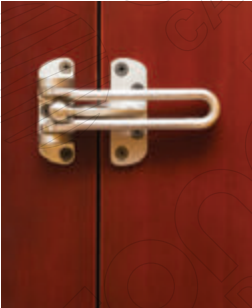

		F				7 74470...				7 74470...	
C813ORB	Oil Rubbed Bronze (C10B)	4-1/8"	5 ◇	100 ◇	51019 1	C813ORBR	5 ◇	51593 6			
C813SAC	Satin Antique Copper (C12A)	4-1/8"	5 ◇	100 ◇	51020 7	C813SACR	5 ◇	51594 3			
C813AN	Antique Nickel (C17A)	4-1/8"	5 ◇	100 ◇	51017 7	C813ANR	5 ◇	51595 0			
C813B	Bright Brass (C3)	4-1/8"	5 ◇	100 ◇	51018 4	C813BR	5 ◇	51824 1			
C813SN	Satin Nickel (C15)	4-1/8"	5 ◇	100 ◇	51022 1	C813SNR	5 ◇	51596 7			
C813SC	Satin Chrome (C26D)	4-1/8"	5 ◇	100 ◇	51021 4	C813SCR	5 ◇	51597 4			
C813AB	Antique Brass (C5)	4-1/8"	5 ◇	100 ◇	51016 0	C813ABR	5 ◇	51598 1			
C813BL	Black	4-1/8"	5 ◇	100 ◇	51567 7	C813BLR	5 ◇	51599 8			

CHAIN DOOR GUARD



		F				7 74470...				7 74470...	
C812B	Bright Brass (C3)	3-1/2"	10 ◇	51211 9	C812BR	8 ◇	51379 6				
C812SC	Satin Chrome (C26D)	3-1/2"	10 ◇	51212 6	C812SCR	8 ◇	51380 2				

LOCKING CHAIN DOOR GUARD

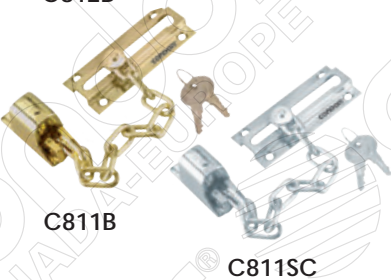

		F				7 74470...				7 74470...	
C811B	Bright Brass (C3)	3-1/2"	10 ◇	51383 3	C811BR	5 ◇	51213 3				
C811SC	Satin Chrome (C26D)	3-1/2"	10 ◇	51384 0	C811SCR	5 ◇	51381 9				

DOOR VIEWERS

Acrylic optical lens



		F				7 74470...				7 74470...	
CB02B	Bright Brass (C3)	160°	2-1/4"	1-3/8"	12 ◇	50806 8	CB02BR	10 ◇	51874 6		
CB03B	Bright Brass (C3)	180°	2-1/4"	1-3/8"	12 ◇	50807 5	CB03BR	10 ◇	51876 0		
CB02SN	Satin Nickel (C15)	160°	2-1/4"	1-3/8"	12 ◇	51741 1	CB02SNR	10 ◇	51875 3		
CB03SN	Satin Nickel (C15)	180°	2-1/4"	1-3/8"	12 ◇	51742 8	CB03SNR	10 ◇	51877 7		

SASH LOCK

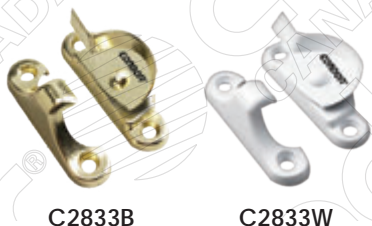

		F				7 74470...				7 74470...	
C2833B	Bright Brass (C3)	2-1/2"	20 ◇	50636 1	C2833BR	12 ◇	51826 5				
C2833W	White	2-1/2"	20 ◇	51255 3	C2833WR	12 ◇	51414 4				



SECRET GATE LATCH

Reversible latch

		F				
C600N	Satin Nickel (C15)	2"	2-1/4"	8 ◇	50633 0	7 74470...



C600N

DOOR FLUSHBOLT

For wooden doors

		F				
C81B	Bright Brass (C3)	6"	3/4"	10 ◇	50476 3	7 74470...



C81B

SASH LOCK

		F					
C2832B	Bright Brass (C3)	2-3/8"	25 ◇	50634 7	C2832BR	12 ◇	51825 8



C2832B

CASEMENT WINDOW LOCK

		F					
C2831B	Bright Brass (C3)	1-7/8"	20 ◇	50474 9	C2831BR	8 ◇	51827 2



C2831B

CUP BOARD LATCH

		F					
C504B30	Bright Brass (C3)	1-7/8"	10 ◇	51258 4	C504B30R	8 ◇	51416 8



C504B30

TRANSOM CATCHES

Die cast case

		F						
C5215SL	Silver	2"	1-1/8"	10 ◇	50475 6	C5215SLR	8 ◇	51855 5



C5215SL

		F						
CDC25SL	Satin Chrome (C26D)	1-3/4"	10 ◇	50635 4	CDC25SLR	6 ◇	51878 4	7 74470...



CDC25SL



F: 1.855.329.8181 T: 1.800.363.9994

◇ breakable pack

SECURITY



FLAGGED



CARDED



STAINLESS STEEL



CAN BE PADLOCKED

STEEL SAFETY HASP

Brass plated, can be padlocked

Part Number	Length	Width	Weight	Quantity	SKU	Part Number	Length	Width	Weight	Quantity	SKU
C34B2	2"	12	◇	50625	5	C34B2R	10	◇	51828	9	51828 9
C34B25	2-1/2"	12	◇	50626	2	C34B25R	8	◇	51829	6	51829 6
C34B3	3"	12	◇	50627	9	C34B3R	8	◇	51830	2	51830 2

LOOSE STAPLE HEAVY DUTY SAFETY HASP

Zinc plated, can be padlocked



Part Number	Length	Width	Weight	Quantity	SKU	Part Number	Length	Width	Weight	Quantity	SKU
C61772	2"	10	◇	200	◇	51328	4	51328 4			
C61773	3"	10	◇	200	◇	50369	8	50369 8			
C617735	3-1/2"	10	◇	160	◇	50370	4	50370 4			
C617745	4-1/2"	10	◇	120	◇	50371	1	50371 1			
C61776	6"	10	◇	60	◇	50372	8	50372 8			

FIXED STAPLE SAFETY HASP

Can be padlocked

Part Number	Material	Length	Width	Weight	Quantity	SKU	Part Number	Length	Width	Weight	Quantity	SKU
C61872	Zinc (C2G)	2"	20	◇	200	◇	51759	6	51759 6			
C618725	Zinc (C2G)	2-1/2"	10	◇	100	◇	51725	1	51725 1			
C618735	Zinc (C2G)	3-1/2"	10	◇	100	◇	51220	1	51220 1			
C618745	Zinc (C2G)	4-1/2"	10	◇	100	◇	51221	8	51221 8			
C61876	Zinc (C2G)	6"	10	◇	100	◇	51222	5	51222 5			
C618BL45	Black	4-1/2"	10	◇	100	◇	51370	3	51370 3			
C618GA45	Galvanized	4-1/2"	10	◇	100	◇	51504	2	51504 2			

● Solid brass pin

STAINLESS STEEL FIXED STAPLE SAFETY HASP

Can be padlocked

Part Number	Material	Length	Width	Weight	Quantity	SKU	Part Number	Length	Width	Weight	Quantity	SKU
C618SS45	TYPE 304	4-1/2"	10	◇	100	◇	51369	7	51369 7			
C618SS45R							5	◇	51228	7	51228 7	

FIXED STAPLE HINGE SAFETY HASP

Zinc plated, can be padlocked

Part Number	Length	Width	Weight	Quantity	SKU	Part Number	Length	Width	Weight	Quantity	SKU
752H3	3"	10	◇	51477	9	752H3R	8	◇	51849	4	51849 4
752H45	4-1/2"	10	◇	51478	6	752H45R	5	◇	51851	7	51851 7



LOCKING HASP

Chrome plated, disc tumbler cylinder with two (2) keys

Part No.	Material	Length	Weight	Quantity	Barcode
710CH3	Chrome (C26)	3"	12 ◇	51739 8	7 74470...
710CH45	Chrome (C26)	4-1/2"	12 ◇	51740 4	7 74470...



Part No.	Weight	Quantity	Barcode
710CH3R	5 ◇	50001 7	7 74470...
710CH45R	5 ◇	50077 2	7 74470...



SWIVEL STAPLE SAFETY HASP

Can be padlocked

Part No.	Material	Length	Weight	Quantity	Barcode
C629Z35	Zinc (C2G)	3-1/2"	10 ◇	51214 0	7 74470...
C629Z45	Zinc (C2G)	4-1/2"	10 ◇	51215 7	7 74470...

Part No.	Weight	Quantity	Barcode
C629Z35R	5 ◇	51831 9	7 74470...
C629Z45R	4 ◇	51832 6	7 74470...



FIXED STAPLE DOUBLE HINGE SAFETY HASP

Can be padlocked

Part No.	Material	Length	Weight	Quantity	Barcode
C619H35	Zinc (C2G)	3-1/2"	10 ◇	51224 9	7 74470...

Part No.	Weight	Quantity	Barcode
C619H35R	5 ◇	51318 5	7 74470...



FIXED STAPLE EXTRA HEAVY DUTY SAFETY HASP

Can be padlocked

Part No.	Material	Length	Weight	Quantity	Barcode
C620Z8	Zinc (C2G)	8"	5 ◇	51321 5	7 74470...

Part No.	Weight	Quantity	Barcode
C620Z8R	4 ◇	51941 5	7 74470...



Part No.	Material	Length	Weight	Quantity	Barcode
C620BL8	Black	8"	5 ◇	51940 8	7 74470...

Part No.	Weight	Quantity	Barcode
C620BL8R	4 ◇	51320 8	7 74470...



BAR HOLDERS

Zinc plated steel

Part No.	Length	Weight	Quantity	Barcode
756	1-1/2"	3-3/4"	6 ◇	51259 1

Part No.	Length	Weight	Quantity	Barcode
757	2"	4"	6 ◇	51260 7

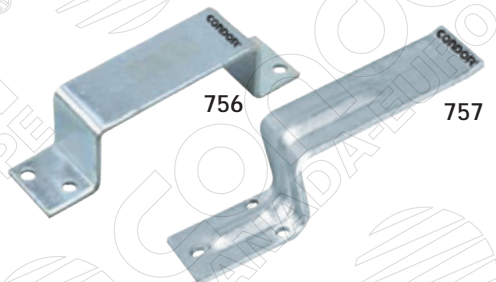



F: 1.855.329.8181 T: 1.800.363.9994

◇ breakable pack

SECURITY



FLAGGED



CARDED



STAINLESS STEEL

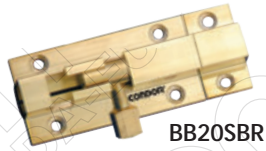

BB20SBR



BB25CHR

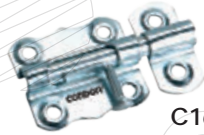

C1693Z2



C1693B25



C1061W50



C1061B50



C1061Z50



C1061SS100

POLISHED SOLID BRASS

BB15SBR	1-1/2"	10 ◇	50095 6	7 74470...
BB20SBR	2"	12 ◇	50097 0	7 74470...
BB25SBR	2-1/2"	12 ◇	50099 4	7 74470...
BB30SBR	3"	8 ◇	50101 4	7 74470...
BB40SBR	4"	8 ◇	50326 1	7 74470...

SOLID BRASS BARREL BOLT

Ball bearing for smooth action

SOLID BRASS POLISHED CHROME FINISH

BB15CHR	1-1/2"	10 ◇	50096 3	7 74470...
BB20CHR	2"	12 ◇	50098 7	7 74470...
BB25CHR	2-1/2"	12 ◇	50100 7	7 74470...
BB30CHR	3"	8 ◇	50102 1	7 74470...
BB40CHR	4"	8 ◇	50307 0	7 74470...

WINDOW BOLT

Reinforced screw holes

C1693Z2	Zinc (C2G)	2"	12 ◇	51331 4	F	C1693Z2R	12	51895 1	7 74470...
C1693B25	Bright Brass (C3)	2-1/2"	12 ◇	50616 3		C1693B25R	12	51896 8	7 74470...
C1693B3	Bright Brass (C3)	3"	12 ◇	50617 0		C1693B3R	8	51897 5	7 74470...
C1693B4	Bright Brass (C3)	4"	12 ◇	50362 9		C1693B4R	8	51898 2	7 74470...

ECONOMY BARREL BOLT

C1061W50	White	2"	20 ◇	51229 4	F	C1061W50R	12	51899 9	7 74470...
C1061B50	Bright Brass (C3)	2"	20 ◇	51231 7		C1061B50R	12	51900 2	7 74470...
C1061B64	Bright Brass (C3)	2-1/2"	12 ◇	51232 4		C1061B64R	12	51901 9	7 74470...
C1061B75	Bright Brass (C3)	3"	12 ◇	51233 1		C1061B75R	8	51902 6	7 74470...
C1061B100	Bright Brass (C3)	4"	10 ◇	51230 0		C1061B100R	8	51903 3	7 74470...
C1061Z50	Zinc (C2G)	2"	20 ◇	50585 2		C1061Z50R	12	51904 0	7 74470...
C1061Z64	Zinc (C2G)	2-1/2"	12 ◇	50614 9		C1061Z64R	12	51905 7	7 74470...
C1061Z75	Zinc (C2G)	3"	12 ◇	50615 6		C1061Z75R	8	51906 4	7 74470...
C1061Z100	Zinc (C2G)	4"	10 ◇	50613 2		C1061Z100R	8	51907 1	7 74470...
C1061Z125	Zinc (C2G)	5"	10 ◇	50602 6					
C1061Z150	Zinc (C2G)	6"	10 ◇	50603 3					

STAINLESS STEEL ECONOMY BARREL BOLT

TYPE 304



C1061SS100		4"	10 ◇	51372 7		C1061SS100R	8 ◇	51322 2	7 74470...

BARREL BOLT

Steel backplate, black jappaned
Plain steel shoot



C161J3

C161J25	2-1/2"	12 ◇	50357 5	7 74470...
C161J3	3"	12 ◇	50358 2	7 74470...
C161J4	4"	12 ◇	50359 9	7 74470...
C161J5	5"	12 ◇	50360 5	7 74470...
C161J6	6"	12 ◇	50361 2	7 74470...

HEAVY DUTY TOWER BOLT

Steel backplate, black jappaned, bright steel shoot



C923A6

C923A4	4"	10 ◇	50376 6	7 74470...
C923A6	6"	10 ◇	50377 3	7 74470...
C923A8	8"	10 ◇	50378 0	7 74470...
C923A10	10"	10 ◇	50375 9	7 74470...



PADBOLT

Zinc plated steel, can be padlocked

100A6	6"	5 ◇	50700 9	7 74470...
100A8	8"	5 ◇	50701 6	
100A10	10"	5 ◇	50702 3	

STAINLESS STEEL PADBOLT

Can be padlocked

100A-SS6	6"	5 ◇	51939 2	7 74470...

HEAVY DUTY PADBOLT

Zinc plated steel, can be padlocked

C106774	4"	5 ◇	51234 8	7 74470...
C106776	6"	5 ◇	51235 5	



EXTRA HEAVY DUTY PADBOLT

Can be padlocked

ZINC PLATED STEEL (C2G)

C1068745	4-1/2"	5 ◇	50596 8	7 74470...
C106876	6"	5 ◇	50597 5	

CHAIN BOLT

Zinc plated steel

C1166Z	6"	5 ◇	51237 9	C1166ZR	5 ◇	51854 8	7 74470...

SECURITY SPRING LOCK

Zinc plated steel

C1168Z	6"	5 ◇	51374 1	C1168ZR	5 ◇	51236 2	7 74470...

DOOR HOLDER

Activated with the foot, silver lacquered cast zinc, sturdy rubber tip

C1014-02	Silver	5-1/4"	6 ◇	50675 0
C1015-02	Silver	8-1/4"	6 ◇	50676 7

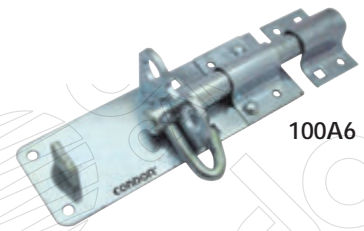

100A6



100A-SS6



C106774

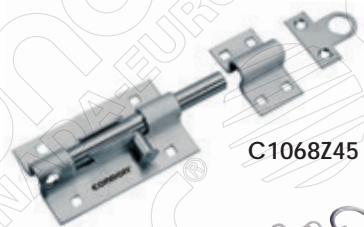

C1068745



C1166Z



C1168Z



C1014-02



F: 1.855.329.8181 T: 1.800.363.9994

◇ breakable pack

DOOR PULLS



FLAGGED



CARDED



STAINLESS STEEL

SCREEN DOOR PULL

		F							
CP475CH	Chrome (C26)	4-3/4"	1 pr	25 pr ◇	50685 9	CP475CHR	1 pr	5 pr ◇	51310 9

STAINLESS STEEL SCREEN DOOR PULL

TYPE 304



CP475SS	4-3/4"	1 un	5 un ◇	51367 3	CP475SSR	1 un	5 un ◇	51238 6

DOOR PULL

Zinc plated steel

2381CH3	3"	12	50384 1	
2381CH4	4"	12	50385 8	
2381CH5	5"	12	50386 5	
2381CH6	6"	12	50387 2	

DOOR PULL

		F						
2381Z55	Zinc (C2G)	5-1/2"	12 ◇	51242 3	2381Z55R	1	6	51892 0
2381Z65	Zinc (C2G)	6-1/2"	12 ◇	51243 0	2381Z65R	1	6	51893 7
2381BL55	Black	5-1/2"	12 ◇	51324 6	2381BL55R	1	6	51894 4
2381BL65	Black	6-1/2"	12 ◇	51246 1	2381BL65R	1	6	51707 7
2381GA65	Galvanized	6-1/2"	12 ◇	51327 7	2381GA65R	1	6	51887 6
2381W65	White	6-1/2"	12 ◇	51375 8	2381W65R	1	6	51325 3

STAINLESS STEEL DOOR PULL

TYPE 304



2381SS65R	6-1/2"	1	6	51376 5	

GARAGE DOOR PULL

Zinc plated steel

2381Z8	8"	10 ◇	50664 4	

HEAVY DUTY DOOR HANDLE

Zinc plated steel

C328Z	6-1/2"	1-1/2"	20 ◇	50333 9

TRAP DOOR RING

Zinc plated steel

C2151	3-1/2"	3"	10 ◇	50364 3

CHEST HANDLE

Zinc plated steel

C2535	4"	20 ◇	50365 0	



C2535



C2151



LIGHT CORNER BRACES

Dimensions	Material	Part No.	QTY	Weight	Barcode	Part No.	QTY	Weight	Barcode	Part No.	QTY	Weight	Image	
3/4" x 3/4" x 0.052"	Zinc (C2G)	MA320-075C	100	1,000	50927 0	MA320-075-P	20	10 (x20)	100 (x20)	50926 3	10 (x20)	100 (x20)	50934 8	
3/4" x 3/4" x 0.054"	White	MA320W-075C	100	1,000	50932 4	MA320W-075-P	20	10 (x20)	100 (x20)	50934 8	10 (x20)	100 (x20)	50934 8	
1" x 1-3/4" x 0.046"	Zinc (C2G)	MA320-175C	100	1,000	50930 0	MA320-175-P	10	10 (x10)	80 (x10)	50929 4	10 (x10)	80 (x10)	50939 3	
1" x 1-3/4" x 0.061"	White	MA320W-175C	100	1,000	50938 6	MA320W-175-P	10	10 (x10)	80 (x10)	50939 3	10 (x10)	80 (x10)	50939 3	



DOUBLE WIDE CORNER BRACE

Zinc plated steel

Dimensions	Material	Part No.	QTY	Weight	Barcode
1-1/2" x 1-1/2" x 0.08"	Zinc	MA323-15BC	10	300	51146 4
2" x 1-1/2" x 0.08"	Zinc	MA323-2BC	10	300	51147 1
2-1/2" x 1-1/2" x 0.08"	Zinc	MA323-25BC	10	250	51148 8



MA323-15BC

CORNER BRACE

Zinc plated steel

Dimensions	Material	Part No.	QTY	Weight	Barcode	Part No.	QTY	Weight	Barcode
3/4" x 3/4" x 0.079"	---	---	---	---	---	MA320S-075BC	40	1,200	50931 7
1" x 1/2" x 0.079"	MA320-1	20	1,000	50480 0	MA320-1BC	20	1,000	50720 7	
1-1/2" x 1/2" x 0.079"	MA320-15	20	1,000	50443 5	MA320-15BC	20	1,000	50721 4	
2" x 5/8" x 0.079"	MA320-2	20	600	50444 2	MA320-2BC	20	600	50722 1	
2-1/2" x 5/8" x 0.079"	MA320-25	20	300	50445 9	MA320-25BC	20	300	50723 8	
3" x 3/4" x 0.094"	MA320-3	20	200	50446 6	MA320-3BC	20	200	50724 5	
3-1/2" x 3/4" x 0.125"	MA320-35	20	200	50447 3	MA320-35BC	20	200	50725 2	
4" x 7/8" x 0.125"	MA320-4	10	150	50448 0	MA320-4BC	10	150	50726 9	
5" x 1" x 0.158"	---	---	---	---	MA320-5BC	10	50	50450 3	
6" x 1-1/8" x 0.188"	---	---	---	---	MA320-6BC	10	50	50451 0	
8" x 1-1/8" x 0.220"	---	---	---	---	MA320-8BC	10	---	50452 7	
10" x 1-1/4" x 0.220"	---	---	---	---	MA320-10BC	10	---	51154 9	

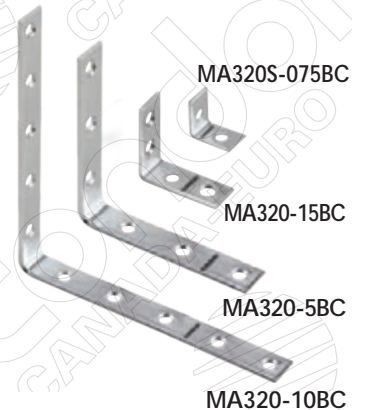



F: 1.855.329.8181 T: 1.800.363.9994

◇ breakable pack

CONSTRUCTION



BULK PACK

7 74470 XXXXX

POLY BAGGED

FLAT CORNER IRON

Zinc plated steel



MA321-15BC

MA321-6BC

MA322-10BC

MA322-3

MA322-2

Length	Width	Thickness	Part No.	QTY	PKT	UNIT	GTIN
2"	5/8"	0.063"	MA322-2	20	2,000	◇	50461 9
2-1/2"	5/8"	0.063"	MA322-25	20	1,000	◇	50462 6
3"	3/4"	0.079"	MA322-3	20	500	◇	50463 3
4"	7/8"	0.098"	---	---	---	---	---
5"	1"	0.098"	---	---	---	---	---
6"	1-1/8"	0.110"	---	---	---	---	---
8"	1-1/4"	0.110"	---	---	---	---	---
10"	1"	0.220"	---	---	---	---	---
12"	1-1/8"	0.303"	---	---	---	---	---

Length	Width	Thickness	Part No.	QTY	PKT	UNIT	GTIN
1-1/2"	3/8"	0.063"	MA321-15BC	20	1,200	◇	50727 6
2"	3/8"	0.063"	MA321-2BC	20	1,200	◇	50728 3
2-1/2"	1/2"	0.063"	MA321-25BC	20	800	◇	50729 0
3"	1/2"	0.063"	MA321-3BC	20	300	◇	50730 6
3-1/2"	5/8"	0.078"	MA321-35BC	20	400	◇	50731 3
4"	5/8"	0.078"	MA321-4BC	20	300	◇	50732 0
5"	7/8"	0.078"	MA321-5BC	20	200	◇	50733 7
6"	1"	0.078"	MA321-6BC	20	200	◇	50734 4

MENDING PLATE

Zinc plated steel



Length	Width	Thickness	Part No.	QTY	PKT	UNIT	GTIN
2"	5/8"	0.063"	MA322-2	20	2,000	◇	50461 9
2-1/2"	5/8"	0.063"	MA322-25	20	1,000	◇	50462 6
3"	3/4"	0.079"	MA322-3	20	500	◇	50463 3
4"	7/8"	0.098"	---	---	---	---	---
5"	1"	0.098"	---	---	---	---	---
6"	1-1/8"	0.110"	---	---	---	---	---
8"	1-1/4"	0.110"	---	---	---	---	---
10"	1"	0.220"	---	---	---	---	---
12"	1-1/8"	0.303"	---	---	---	---	---

DOUBLE WIDE MENDING PLATE

Zinc plated steel



MA355-15-P

MA355-25-P

MA355-35-P

Length	Width	Thickness	Part No.	QTY	PKT	UNIT	GTIN	
1-1/2"	1-3/8"	0.060"	MA355-15-P	4	20 (x4)	300	◇	51155 6
2-1/2"	1-3/8"	0.060"	MA355-25-P	4	20 (x4)	200	◇	51156 3
3-1/2"	1-3/8"	0.060"	MA355-35-P	4	20 (x4)	140	◇	51157 0

T-PLATE

Zinc plated steel



MA325-3BC

Length	Width	Thickness	Part No.	QTY	PKT	UNIT	GTIN	
2-1/2"	1/2"	2"	0.078"	MA325-25BC	10	500	◇	50743 6
3"	5/8"	2-3/8"	0.078"	MA325-3BC	10	100	◇	50744 3
4"	3/4"	3-1/4"	0.078"	MA325-4BC	10	100	◇	50745 0
5"	1"	4"	0.078"	MA325-5BC	10	100	◇	50746 7

HEAVY DUTY TRIANGLE CORNER BRACE

Zinc plated steel



MA324-3BC

Length	Width	Thickness	Part No.	QTY	PKT	UNIT	GTIN	
2"	2-3/4"	5/8"	0.063"	MA324-2BC	10	300	◇	51149 5
3"	4-1/8"	3/4"	0.092"	MA324-3BC	10	250	◇	51150 1
4"	5-1/2"	1"	0.099"	MA324-4BC	10	100	◇	51151 8



7 74470 0XXXXX 1X

FLAGGED



BOXED BY PAIR



WORKING LOAD LIMIT

HEAVY DUTY SHELF BRACKET

Very strong enamelled steel bracket to support heavy loads
One pair can support over 660 lbs depending on the size of the brackets, when the weight is evenly distributed on the shelf

WHITE

21-812	8"	12"	1-3/16"	3/16"	660/pr	10 ◇	50840 2	7 74470...
21-1016	10"	16"	1-3/16"	3/16"	660/pr	10 ◇	50841 9	7 74470...
21-1320	13"	20"	1-3/16"	3/16"	440/pr	10 ◇	50842 6	7 74470...



21-812



436

FOLDING SHELF BRACKET

Wrought enamelled steel

WHITE

436	8"	24 pr ◇		50070 3
437	12"	18 pr ◇		50071 0
438	16"	18 pr ◇		50072 7

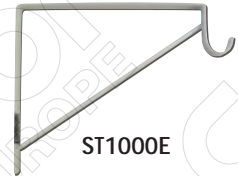

ST1000E

SHELF & ROD SUPPORT

Polyester finish steel

WHITE

ST1000E	11"	1"	20 ◇			52102 9

ORNAMENTAL SHELF BRACKET

Comes complete with point of purchase display box
Just remove the lid

BLACK

WHITE

342BL-53	3-1/2"	5"	10 ◇			51434 2	342W-53	10 ◇				51437 3
342BL-85	5-1/2"	8"	10 ◇			51435 9	342W-85	10 ◇				51438 0
342BL-107	7"	10"	10 ◇			51436 6	342W-107	10 ◇				51439 7



342W-53

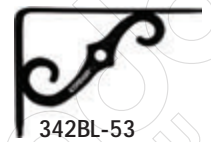

342BL-53

SHELF BRACKET

Enamelled steel

GREY

WHITE

326-34	3"	4"	20	120 ◇			50122 9	337-34	20	120 ◇			50412 1
326-45	4"	5"	20	120 ◇			50123 6	337-45	20	120 ◇			50413 8
326-56	5"	6"	20	120 ◇			50124 3	337-56	20	120 ◇			50414 5
326-68	6"	8"	20	120 ◇			50125 0	337-68	20	120 ◇			50415 2
326-79	7"	9"	20	120 ◇			50126 7	337-79	20	120 ◇			50416 9
326-810	8"	10"	20	120 ◇			50127 4	337-810	20	120 ◇			50417 6
326-1012	10"	12"	20	60 ◇			50120 5	337-1012	20	60 ◇			50410 7
326-1214	12"	14"	20	60 ◇			50121 2	337-1214	20	60 ◇			50411 4



337-34



326-34

DISPLAY RACKS

Steel wire display rack, for grey and white shelf brackets

- No 326-34 & 337-34
- No 326-45 & 337-45
- No 326-56 & 337-56
- No 326-68 & 337-68

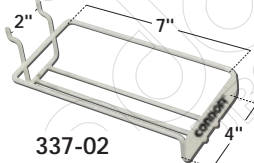

337-02

- No 326-79 & 337-79
- No 326-810 & 337-810
- No 326-1012 & 337-1012
- No 326-1214 & 337-1214

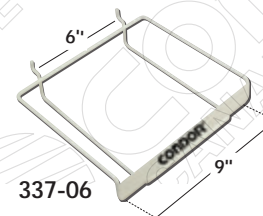

337-06



F: 1.855.329.8181 T: 1.800.363.9994

◇ breakable pack

STORAGE



FLAGGED



CARDED



MINIMAL LENGTH



MAXIMAL LENGTH

ADJUSTABLE CLOSET ROD



SILVER COATED

CR1830



WHITE

CR1830W

● CR1830		18"	30"	1"		51181 5
● CR3048		30"	48"	1"		51301 7
● CR4872		48"	72"	1"		51481 6
● CR7296		72"	96"	1"		51721 3
● CR9612		96"	120"	1"		51961 3

● Central support included

● CR1830W		18"	30"	1"		51401 4
● CR3048W		30"	48"	1"		51402 1
● CR4872W		48"	72"	1"		51403 8
● CR7296W		72"	96"	1"		51404 5
● CR9612W		96"	120"	1"		51405 2

● Central support included

ADJUSTABLE CLOSET ROD WITH FIXED ENDS



SILVER COATED

CRF1830



WHITE

CRF1830W

● CRF1830		18"	30"	1"		51392 5
● CRF3048		30"	48"	1"		51393 2
● CRF4872		48"	72"	1"		51394 9
● CRF7296		72"	96"	1"		51395 6
● CRF9612		96"	120"	1"		51396 3

● Central support included

● CRF1830W		18"	30"	1"		51406 9
● CRF3048W		30"	48"	1"		51407 6
● CRF4872W		48"	72"	1"		51408 3
● CRF7296W		72"	96"	1"		51409 0
● CRF9612W		96"	120"	1"		51410 6

● Central support included

CLOSET ROD ACCESSORIES

Easy installation

CENTRAL SUPPORT

● CR1000		18"	30"	1"		51427 4
● CR1000W		18"	30"	1"		51397 0

CENTRAL SUPPORT

● CR1000R		18"	30"	1"		51837 1
● CR1000WR		18"	30"	1"		51425 0

END SUPPORT

● CR1500		18"	30"	1"		51424 3
● CR1500W		18"	30"	1"		51398 7

END SUPPORT

● CR1500R		18"	30"	1"		51838 8
● CR1500WR		18"	30"	1"		51422 9

END SUPPORT

● CR1501B		18"	30"	1"		51428 1

END SUPPORT

● CR1501BR		18"	30"	1"		51399 4

END SUPPORT

● CR1502W		18"	30"	1"		51400 7

END SUPPORT

● CR1502WR		18"	30"	1"		51429 8



CR1000



CR1000W



CR1500



CR1500W



CR1501B



CR1502W

50-30

Technical specifications are subject to change without prior notice
 condor is a registered trademark of Canada-Europe Ltd.
 Representation or reproduction of this document in any form or by any means is strictly prohibited.





7 74470...

STORAGE HOOKS

Vinyl coated hooks

Type	A	B	C	D	Box	Box	Barcode
AN5250WBC	4"	3/16"	2"	3-3/8"	20	200 ◇	50970 6
AN5251RBC	7"	3/8"	3-5/8"	4-1/2"	10	50 ◇	50962 1
AN5252RBC	6"	5/16"	2"	5"	10	100 ◇	50963 8
AN5253RBC	7-1/2"	3/8"	5-1/8"	6-1/2"	10	100 ◇	50964 5
AN5255RBC	5-3/4"	● 3/8"	1-5/8"	4"	10	50 ◇	50965 2
AN5256RBC	5"	5/16"	1-1/8"	4"	10	100 ◇	50966 9
AN5257RBC	4"	5/16"	1-5/8"	3"	10	100 ◇	50967 6
AN5258RBC	2-3/4"	1/4"	1"	2-1/4"	10	200 ◇	50968 3
AN5259RBC	3-1/4"	1/4"	1"	6"	10	200 ◇	50969 0

● Wire diameter

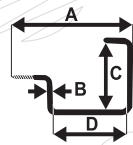
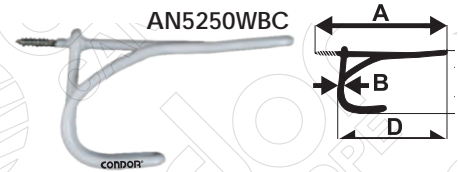

AN5251RBC

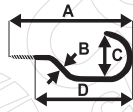

AN5252RBC

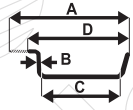
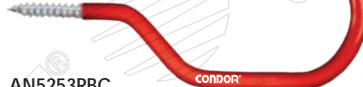

AN5253RBC

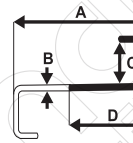

AN5255RBC

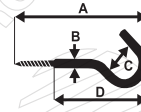

AN5256RBC

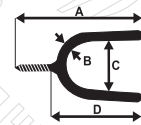

AN5257RBC

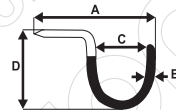

AN5258RBC

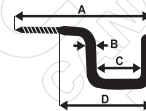

AN5259RBC



STORAGE BIN

Molded from durable polypropylene, red colour
 Other sizes, colours and dividers available on request

Model	Length	Width	Height	Box	Box	Barcode
603P	7-3/8"	4-1/8"	3"	24 ◇	30139 3	7 74470...
604P	10-7/8"	5-1/2"	5"	12 ◇	30140 9	7 74470...
602P	14-3/4"	8-1/4"	7"	12 ◇	30138 6	7 74470...



604P

WALL DISPLAY PANEL

Formed from 16 gauge enameled steel
 BINS NOT INCLUDED
 Can combine the following bins :
 72 bins of 603P or,
 32 bins of 604P or,
 21 bins of 602P or,
 a combination of above bins
 Bins sold separately

Model	Length	Width	Box	Barcode
720M	24-3/4"	49-3/4"	5 ◇	30359 5

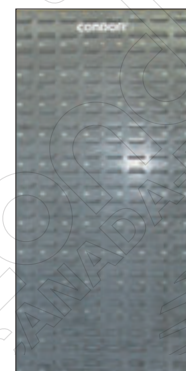
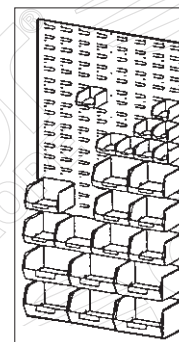

720M



F: 1.855.329.8181 T: 1.800.363.9994

◇ breakable pack

CASTERS



7 74470 XXXXX X



WORKING LOAD LIMIT

FURNITURE CASTER

Chrome plated steel frame
SWIVEL TYPE

« hammer » brand

420B15			1-1/2"	2-3/16"	5/16"	1-1/2"	24	8	160 ◇	50247 9
420B2			2"	2-1/2"	5/16"	1-1/2"	66	8	120 ◇	50248 6

420B15

CASTERS

Standard swivel plate or rigid,
chrome plated steel frame,
double ball bearing
SWIVEL TYPE

« hammer » brand

420G125			1-1/4"	1-5/8"	1-1/2"	1-1/4"	27	16	480 ◇	50227 1
420G15			1-1/2"	2"	1-13/16"	1-1/2"	45	8	240 ◇	50228 8
420G2			2"	2-1/2"	2-5/16"	1-7/8"	65	4	120 ◇	50229 5
420G25			2-1/2"	3-1/8"	2-3/4"	2-1/4"	88	4	60 ◇	50230 1
420G3			3"	3-1/2"	2-3/4"	2-1/4"	110	4	60 ◇	50231 8

420G125

RIGID TYPE

420R125			1-1/4"	1-5/8"	1-7/16"	25/32"	27	20	480 ◇	50232 5
420R15			1-1/2"	2"	1-13/16"	1"	45	8	240 ◇	50233 2
420R2			2"	2-1/2"	2-1/4"	1-9/16"	65	4	120 ◇	50234 9
420R25			2-1/2"	3-1/8"	2-3/4"	2-7/8"	88	4	60 ◇	50235 6
420R3			3"	3-1/2"	2-3/4"	2-7/8"	110	4	60 ◇	50236 3

420R125

INDUSTRIAL CASTERS

Heavy duty swivel plate or rigid, chrome plated steel frame,
double ball bearing, heavy duty model with brake,
tempered steel hub, thick rubber wheel

« hammer » brand

SWIVEL TYPE WITH BRAKE

415ER2			2"	2-1/2"	2-3/4"	1-11/16"	66	4	96 ◇	50243 1
415ER25			2-1/2"	3-1/4"	2-3/4"	1-11/16"	66	4	60 ◇	50244 8
415ER3			3"	3-9/16"	2-3/4"	1-11/16"	88	4	60 ◇	50245 5
415ER4			4"	4-3/4"	3-15/16"	2-1/4"	110	2	40 ◇	50246 2

415ER2

SWIVEL TYPE

420S4			4"	5-3/16"	3-1/2"	3-1/2"	265	1	20 ◇	50240 0
420S5			5"	6-5/8"	4"	4"	330	1	12 ◇	50241 7
420S6			6"	7-1/2"	4"	4"	352	1	12 ◇	50242 4

420S4

RIGID TYPE

420R4			4"	5-3/16"	4-5/16"	3"	265	1	20 ◇	50237 0
420R5			5"	6-5/8"	5-1/2"	3-11/16"	330	1	12 ◇	50238 7
420R6			6"	7-1/2"	5-1/2"	3-11/16"	352	1	12 ◇	50239 4

420R4